



# Metal radiant ceilings

With SAPP<sup>®</sup> and EASY-KLIMA<sup>®</sup>, indoor comfort is constantly under control, efficient, sustainable and at the same time a design element thanks to its modularity and linearity.



Architect' Firm: Roberto Nicoletti Architettura & Design – Photo credits: Marco Zanta

## The metal ceiling radiant system

With SAPP® and EASY-KLIMA®, indoor comfort, whether heating or cooling, is always under control, efficient and sustainable.

The particular modularity and linearity of the metal fins allow many creative construction solutions.

The regular, essential and carefully designed surface of each individual metal element makes it possible to create a neutral, seamless space within rooms, allowing full integration into any type of design. The linear design of the metal slats emphasises the volume of the room without visually interfering with other furnishings. The ceilings are available in four basic colours, but we can make the slats in any colour to characterise any room. Inside the ceiling, it is possible to anticipate the installation of various technical elements such as lighting (recessed and suspended), ventilation, fire detectors, etc. at the design stage. In a few simple steps, it is possible to add other elements at a later stage (e.g. a partition) without affecting the smooth operation of the radiant system.



## Modularity for large areas

The design and implementation of large area ceilings can be complex because it is influenced by a number of important factors such as the geometry of the environment and the intended use (offices, commercial areas, clinics, auditoriums, classrooms, etc.).

The modularity of SAPP® and EASY-KLIMA® allows each individual ceiling element to be adapted to the environment, facilitating design and installation on site. In fact, these systems are not made up of rigid, unchangeable panels, but of beams that can be easily adapted to the shape of the spaces in which they will be installed (e.g. irregular perimeter, curved walls, other creative architectural solutions). The modularity of the ceiling will give the rooms a sense of continuity and width, without any interruption; the radiant system, housed in the metal panels, will ensure ideal comfort in all seasons.



## Less connections, easy maintenance

Our metal ceilings reduce the number of connections by up to 90% compared to other systems, allowing the system to be installed more quickly. Hydraulic connections are made only at the manifold, which is usually located in corridors or technical areas, rather than in offices, conference rooms or other work areas, ensuring that activities can continue uninterrupted if work is carried out on the connections. Metal radiant ceilings are static terminals that contain no motors or filters, making them maintenance free. Moving or adding partitions does not require any intervention on the hydraulic part.

In order to guarantee high efficiency, the contact between the pipes and the metal surface is made by means of specially designed clips, SAPP-Clips® and Easy-Plus Clips®, to ensure a constant and homogeneous distribution of temperature on all the fins or panels, thus achieving high efficiency.

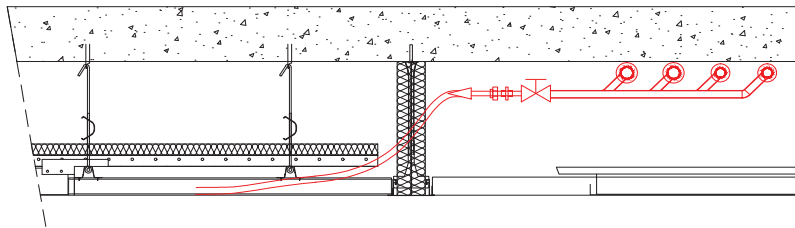

**SAPP®**  
metal ceiling circuit

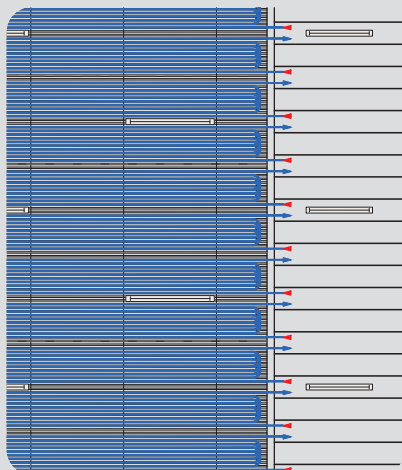

**EASY-KLIMA®**  
metal ceiling circuit

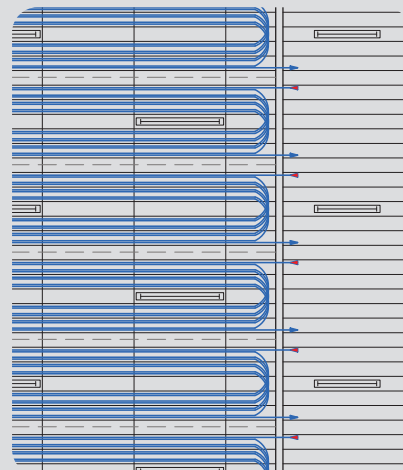





## Quick and easy installation system

SAPP® and EASY-KLIMA® use a quick fixing system that simplifies installation. In fact, the metal ceiling is made up of a special metal profile equipped with a series of special clips that make it easy to fix the pipe and then the metal covering strip.

The profiles are anchored to the overlying support structure by means of a pendant. The suspension frame structure is invisible and is designed so that each panel can be removed individually without the need for special tools. This type of assembly allows all metal slats, even long ones, to be joined perfectly and quickly.

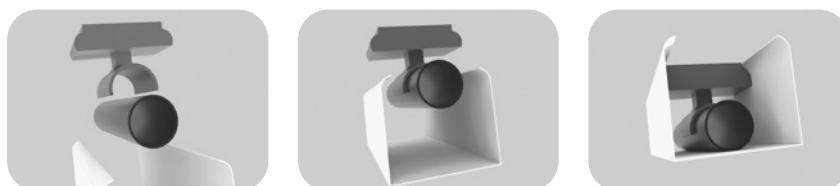

*Example of the SAPP® metal ceiling fixing system.  
By applying light pressure, the pipe is easily fixed to the clip, then the metal slats are inserted into the frame profile. Each bar has the same joint as the one next to it.*

## No more reverberation, perfect acoustics

The excellent acoustic properties of metal ceilings ensure that both ambient noise and reverberation caused by activities in the workplace are eliminated.

Reverberation is often present in rooms with large surfaces, where excessive multiple reflection of sound waves causes the typical “rumble”. In speech environments (offices, meeting rooms, restaurants, theatres, clinics, etc.), the persistent presence of reverberation sometimes makes speech unintelligible and listening difficult. In everyday life, we associate the problem of reverberation with discomfort that can negatively affect our work activities.

The metal blades of SAPP® and EASY-KLIMA® ceilings have been specially designed with a geometry that reduces the reflection of sound waves that cause reverberation. The use of insulating panels positioned on the ceiling support structure makes the absorption of background noise almost total, creating an environment of high acoustic comfort.

SAPP® and EASY-KLIMA® metal ceilings also have excellent sound-absorbing properties: any reverberation is significantly reduced, creating a comfortable working environment. Depending on the function of the room, acoustic barriers can be used to reduce noise between offices or between offices and corridors.

### Optional vertical acoustic barrier

An acoustic barrier is installed vertically above the anchoring/fixing profiles.

This barrier is only installed above the partition (band grid), e.g. between office and corridor or office and office.

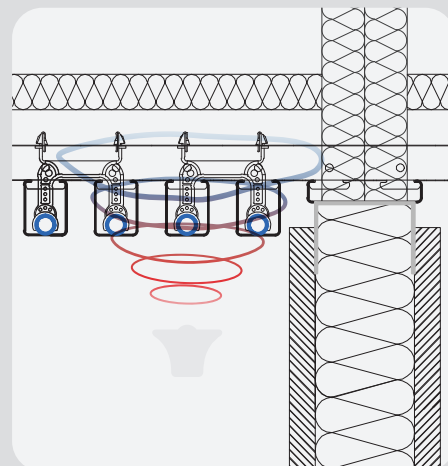
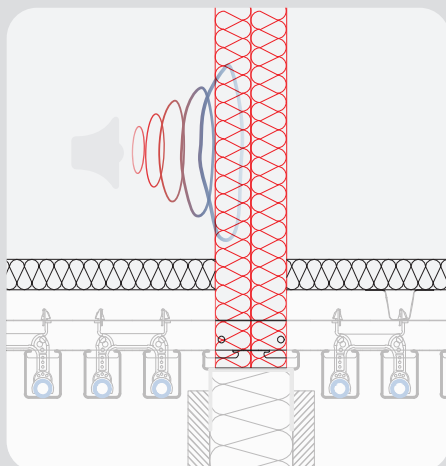







Ak Engineering – Photo credits: Sonia De Boni

## The green solution **for thermal and acoustic comfort**

The SAPP® (Smart Acoustic Passive Power) metal ceiling is the solution for those who demand the highest standards of sustainability and environmental friendliness, without compromising on acoustic and thermal comfort.

SAPP® lends itself to any creative architectural solution thanks to its open, continuous and harmonious structure, which can be elegantly and discreetly integrated into any style of interior. The ceiling is made up of steel slats spaced 20 mm apart and 30 mm wide, and MidiX Plus 14 x 1.25 mm pipes. The slats and pipes are fixed to a frame using a quick-fix system.



### **WATCH THE SAPP® METAL CEILING VIDEO**

Scan the QR code with your smartphone and watch the SAPP® metal ceiling installation and operation video.



## SAPP<sup>®</sup> metal ceiling: aesthetics, comfort and high performance



### High design aesthetics

The elegance and linearity of the metal ceiling enhances aesthetics and blends into any environment.



### Low energy consumption

The intelligent management system and quick start-up ensure maximum comfort and low consumption.



### High efficiency all year round

Operation tailored to climatic and environmental requirements, in both heating and cooling modes.



### Optimum acoustic performance for large areas

Excellent sound absorption properties significantly reduce the reverberation typical of large workspaces.



### Safe, easy and quick installation system

The system is equipped with special clips that allow both the pipe and the metal slat to be easily locked in place.

## The **SAPP**<sup>®</sup> system

The SAPP<sup>®</sup> ceiling is made up of recycled steel slats that form a module with full/empty ratios at a constant distance of 50 mm. The suspension frame is made of 0.6 mm thick black steel profiles pre-painted on both sides and measuring 25 mm high and 55 mm wide. The profiles are punched every 50 mm (with a 20 mm gap in between) to allow the panels of each module to be cut out (for different lengths) and fitted. The profiles are attached to the overlying support structure by means of hangers. The suspension frame structure is invisible and is designed so that each panel can be removed individually without the need for special tools. To achieve a uniform finish and to allow for expansion, an L-shaped finishing profile is placed around the perimeter of the ceiling area to support the walls.

To ensure high efficiency, the contact between the pipes and the fins is made by means of a special clip, SAPP-Clips<sup>®</sup>, designed to ensure a constant and homogeneous temperature distribution on the surface of the fins, thus achieving high efficiency.

### Composition of the SAPP<sup>®</sup> system



1. Insulating material
2. SAPP-Clips<sup>®</sup>
3. MidiX Plus pipe
4. SAPP<sup>®</sup> system steel slats



The ceiling system works with heat pumps, geothermal and other environmentally friendly sources that significantly reduce both energy waste and environmentally harmful emissions. Only steel was used in its construction, thus avoiding energy-consuming and polluting processes.





Architect' Firm: Roberto Nicoletti Architettura & Design – Photo credits: Marco Zanta

## Heating performance



### WINTER

Curves from yield certificates according to UNI EN 14037-5:2016 in heating.

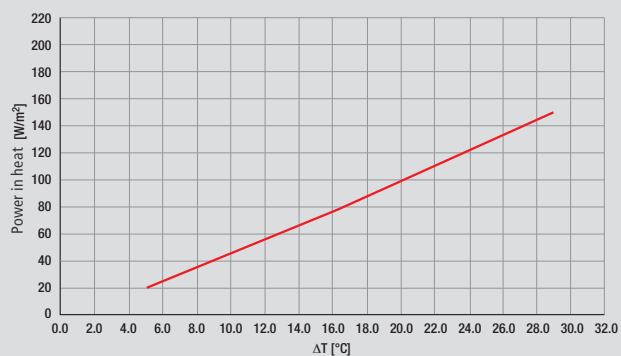

$\Delta T$  between mean water temperature and reference room temperature = 15 K **71 W/m<sup>2</sup>** (in accordance with EN14037)

## Cooling performance



### SUMMER

Curves from yield certificates according to UNI EN 14037-5:2016 in cooling.

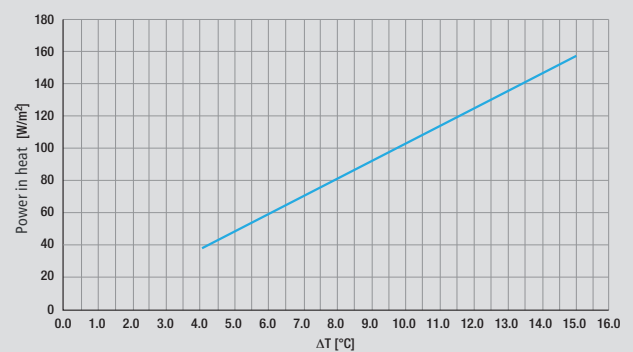

$\Delta T$  between reference ambient temperature and average water temperature = 10 K **103 W/m<sup>2</sup>** (in accordance with EN14240)

## Technical features of the SAPP® system

The SAPP® ceiling is made of steel slats with open joints, resulting in a module with full/empty ratios at 50 mm intervals.

The ceilings are installed to obtain perfectly horizontal surfaces, with perfect integration of all mechanical and lighting components.

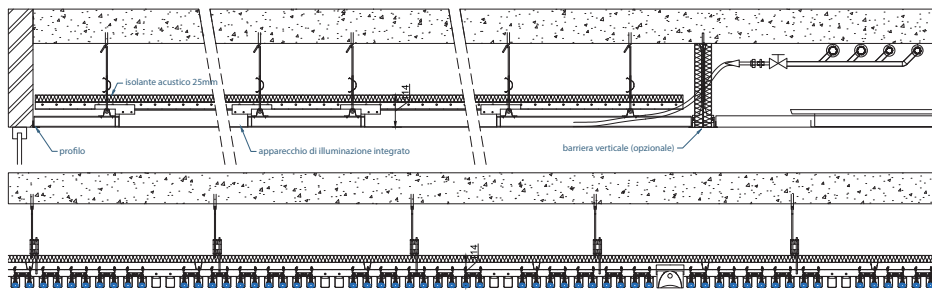

### General features

Width	28.5 mm (joint 21.5 mm)
Height	38 mm
Perforation diameter*	ø 1 millimetre ± 20%
Pipe	MidiX Plus 14 x 1.25 mm

\* in the SAPP® version with perforated slat

### Slat characteristics

Composition	Fe P02 GZ 100S steel
Thickness	0.4 mm
Elasticity module	210 N/mm <sup>2</sup>
Tensile strength	280 – 320 N/mm <sup>2</sup>
Melting point	1630 °C
Coefficient of expansion	0.012 mm/m/ °C

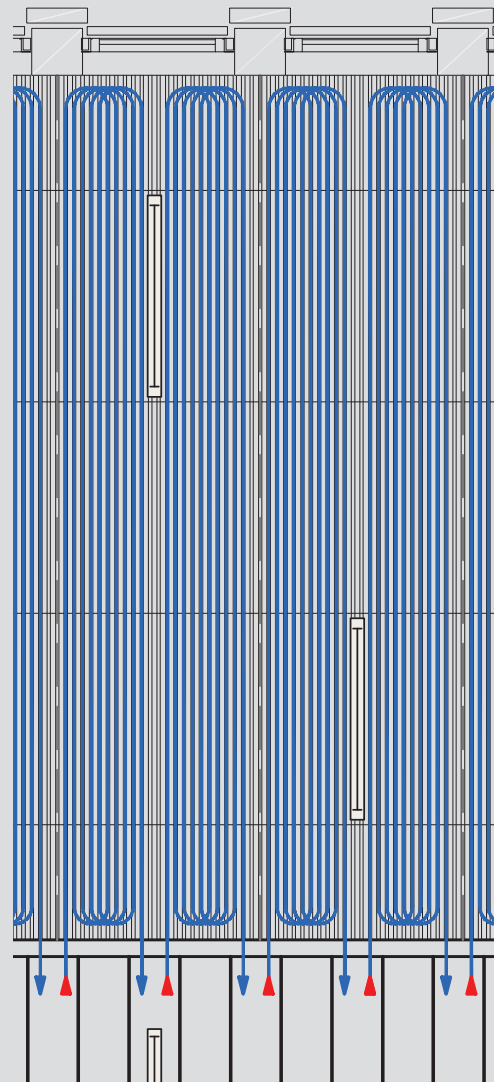
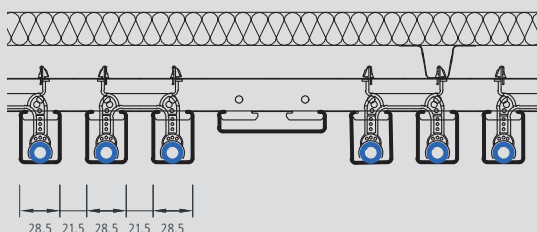

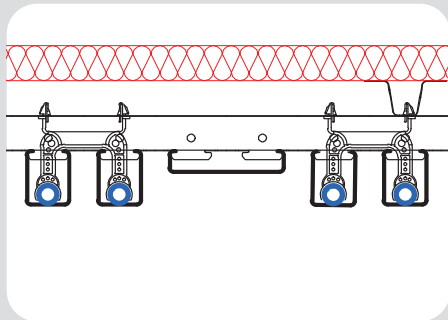

### Insulation

To improve sound absorption, a polyester fibre or mineral wool bag insulation board is installed ~80 mm above the ceiling. The sound absorption rating is  $\alpha_w = 0.85$ .

### Vertical insulation (optional)

In order to achieve good sound absorption between the different offices, rigid insulation panels made of mineral wool covered with aluminium foil, cut to size according to specific requirements, can be installed above the Omega (bandraster) as an option, acting as vertical sound barriers.

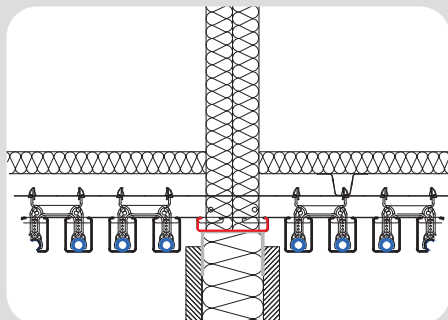
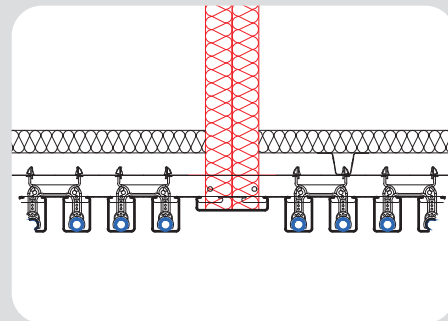

### Example of partition structure

To divide offices or corridors, an invisible Omega-type profile (bandraster) can be installed. The partitions between the various rooms are then positioned underneath this profile.

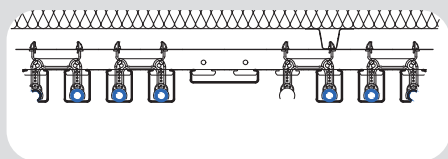

1. Suspension with quick coupling system

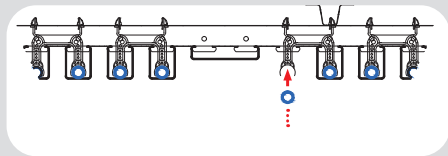

2. Pipe housing

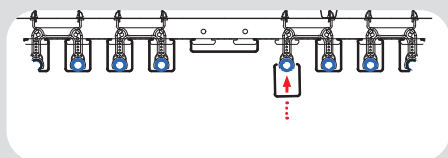

3. Steel slat housing

### Fixing the frame

The suspension frame is made from black steel profiles, pre-painted on both sides with baked enamel, 0.6 mm thick, 25 mm high and 55 mm wide. The profiles are punched every 50 mm (with a 20 mm gap in between) to allow the panels of each module to be cut (to different lengths) and fitted. The profiles are attached to the overlying support structure by means of hangers. The suspension frame structure is invisible and is designed so that each panel can be removed individually without the need for special tools.





## Easy to install and maintenance free

A perfect combination of aesthetics and functionality, very easy to install and fully integrated into the environment, EASY-KLIMA® is the ideal solution for heating and cooling working environments.

It is a versatile and cost-effective ceiling that contributes to an extremely comfortable climate and acoustics, without neglecting aesthetics. Metal ceilings are designed to create a continuous line in the space and to integrate elegantly and discreetly into any interior style. The ceiling consists of 0.5 mm thick, uniformly perforated steel slats and MidiX Plus 14 x 1.25 mm pipes. The metal slats and pipes are fastened to a frame by means of a quick-binder system.



**DISCOVER OUR ONLINE CONFIGURATOR**

Scan the QR code with your smartphone, configure and calculate the price of your radiant ceiling system in minutes.

Or go directly to the dedicated website [soffittoradiante24.it](http://soffittoradiante24.it)

# EASY-KLIMA®

the versatile and adaptable ceiling



## High design aesthetics

The elegance and linearity of the metal ceiling enhances aesthetics and blends into any environment.



## Low energy consumption

The intelligent management system and quick start-up ensure maximum comfort and low consumption.



## High efficiency all year round

Operation tailored to climatic and environmental requirements, in both heating and cooling modes.



## Optimum acoustic performance for large areas

Excellent sound absorption properties significantly reduce the reverberation typical of large workspaces.



## Safe, easy and quick installation system

The system is equipped with special clips that allow both the pipe and the metal slat to be easily locked in place.

## The **EASY-KLIMA**<sup>®</sup> system

The ceiling consists of micro-perforated recycled steel slats. The standard forometry has Ø 2 mm holes and a perforation rate of approximately 18%, resulting in a uniformly perforated ceiling. The ceiling is installed to give a perfectly horizontal and continuous surface. The suspension frame is made of black steel profiles pre-painted on both sides with a 0.6 mm thick, 29 mm high and 32 mm wide baked enamel finish.

The profiles are punched every 25 mm to allow the panels of each module to be cut out and fitted. The upper part of the support frame is provided with fasteners every 25 mm to allow the support profile to be fastened to the support frame with a quick-binder. The support frame structure is invisible and is designed so that each panel can be removed individually without the need for special tools.

To achieve a uniform finish and allow for expansion, a C-shaped finishing profile is positioned around the perimeter of the ceiling area to support the walls. To ensure high efficiency, the contact between the pipes and the panel is made using a specially designed clip, Easy-Plus Clips<sup>®</sup>, to ensure a constant and homogeneous temperature distribution over the surface of the panels, thus achieving high efficiency.

### Composition of the **EASY-KLIMA**<sup>®</sup> system

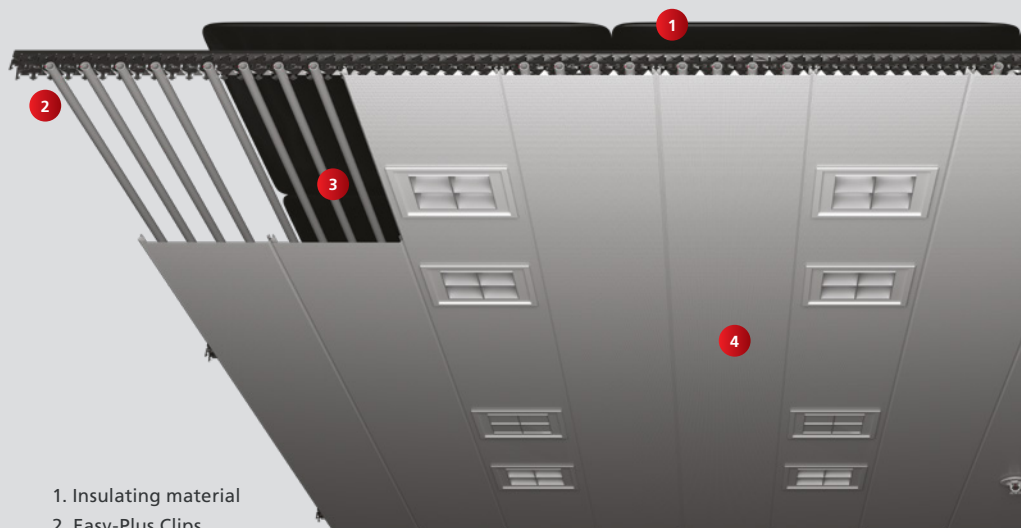
1. Insulating material
2. Easy-Plus Clips
3. MidiX Plus pipe
4. **EASY-KLIMA**<sup>®</sup> system steel slats



The ceiling system works with heat pumps, geothermal and other environmentally friendly sources that significantly reduce both energy waste and environmentally harmful emissions. Only steel was used in its construction, thus avoiding energy-consuming and polluting processes.





### Heating performance



#### WINTER

Curves from yield certificates according to UNI EN 14037-5:2016 in heating.

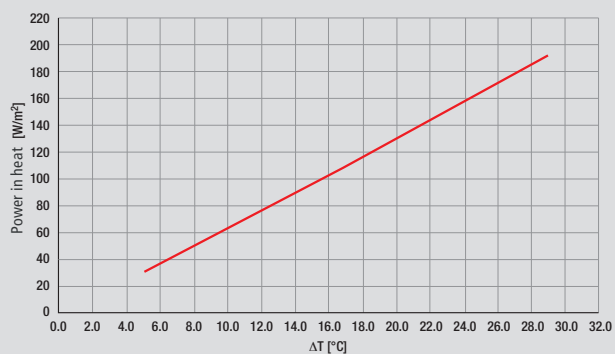

$\Delta T$  between mean water temperature and reference room temperature = 15K **96 W/m<sup>2</sup>** (in accordance with EN14037)

### Cooling performance



#### SUMMER

Curves from yield certificates according to UNI EN 14240:2005 in cooling.

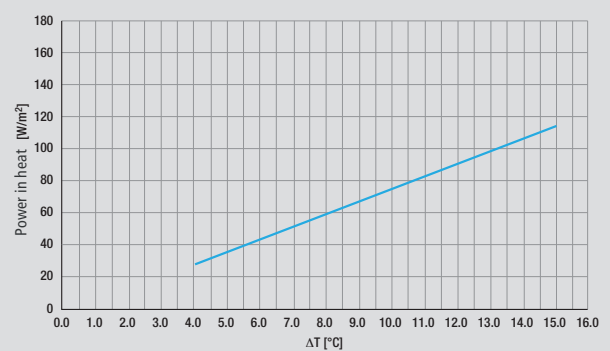

$\Delta T$  between reference ambient temperature and average water temperature = 10 K **74 W/m<sup>2</sup>** (according to EN14240)

## Technical features of the EASY-KLIMA® system

The ceiling is made of perforated steel slats. The standard configuration is with 2 mm holes. Other hole patterns are available on request. The ceilings are installed to provide perfectly horizontal surfaces with perfect integration of all mechanical and lighting components.

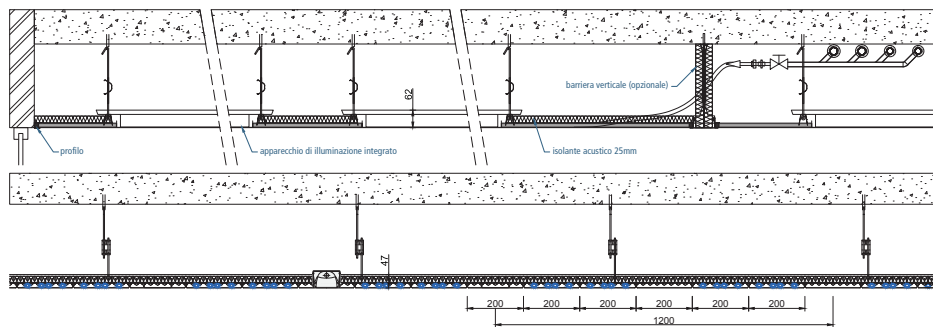

### General features

<b>Width</b>	from 100 to 225 mm*
<b>Height</b>	50 mm
<b>Perforation diameter*</b>	ø 2 millimetre ~16%-18%
<b>Pipe</b>	MidiX Plus 14 x 1.25 mm

\* depending on project type

### Slat characteristics

<b>Composition</b>	Fe P02 GZ 100S steel
<b>Thickness</b>	0.5 mm
<b>Elasticity module</b>	210 N/mm <sup>2</sup>
<b>Tensile strength</b>	280 – 320 N/mm <sup>2</sup>
<b>Melting point</b>	1630 °C
<b>Coefficient of expansion</b>	0.012 mm/m/ °C

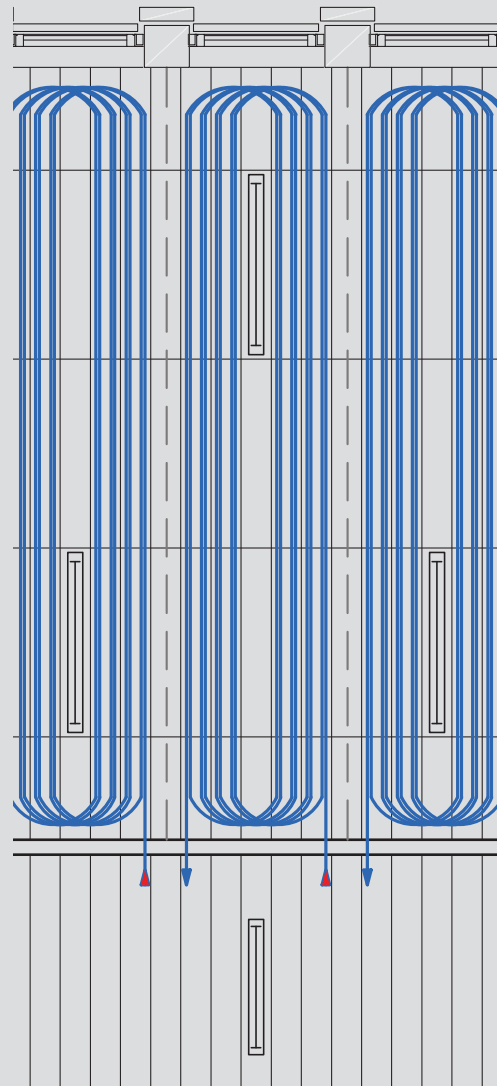
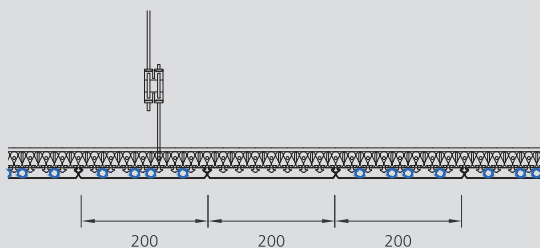

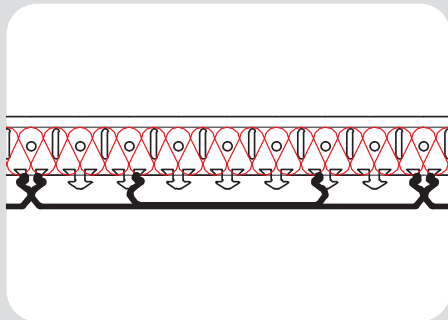

### Bagged glass fibre insulation

To improve sound absorption, a sealed mineral wool insulation board (bagged in PE film), 25 mm thick – density 36 kg/m<sup>3</sup>, is installed above the ceiling.

Hz	125	250	500	1000	2000	4000
$\alpha_s$	0.39	0.82	0.97	0.87	0.98	0.91

### Vertical insulation (optional)

In order to achieve good sound absorption between the different offices, rigid insulation panels made of mineral wool covered with aluminium foil, cut to size according to specific requirements, can be installed above the Omega (bandraster) as an option, acting as vertical sound barriers.

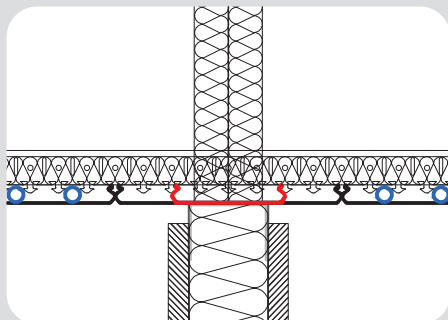
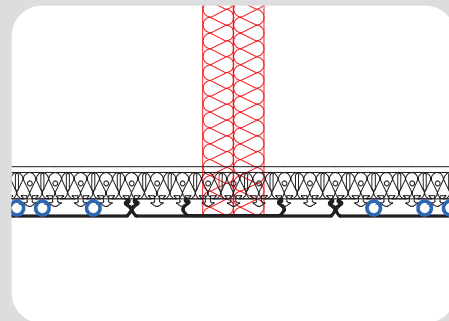

### Example of partition structure

To divide offices or corridors, an omega-type profile (bandraster) can be installed with sufficient reinforcement to support the wall. In terms of finish, perforation and shape, this panel is identical to the other ceiling panels and is therefore undetectable, thus ensuring the continuity of the ceiling.

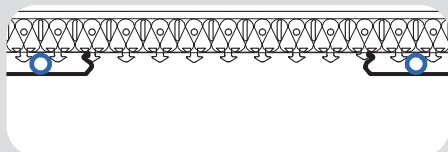

1. Hanging structure with quick-attach system

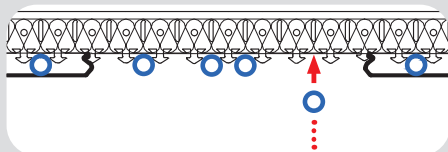

2. Pipe housing

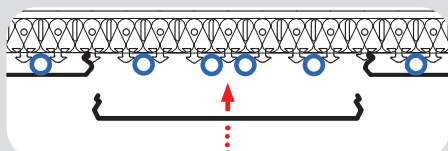

3. Steel slat housing

### Fixing the frame

The suspension frame is made from black steel profiles pre-painted on both sides with a stove enamel finish, 0.6 mm thick, 39 mm high and 32 mm long. The profiles are punched every 25 mm to allow the panels of each module to be cut to length and fitted. The upper part of the beam has fixing grooves every 50 mm to allow the beam to be fixed to the frame with a quick-binder. The support frame structure is invisible and is designed so that each panel can be removed individually without the need for special tools.





More quality for the indoor **climate**.  
 More value for **well-being**.

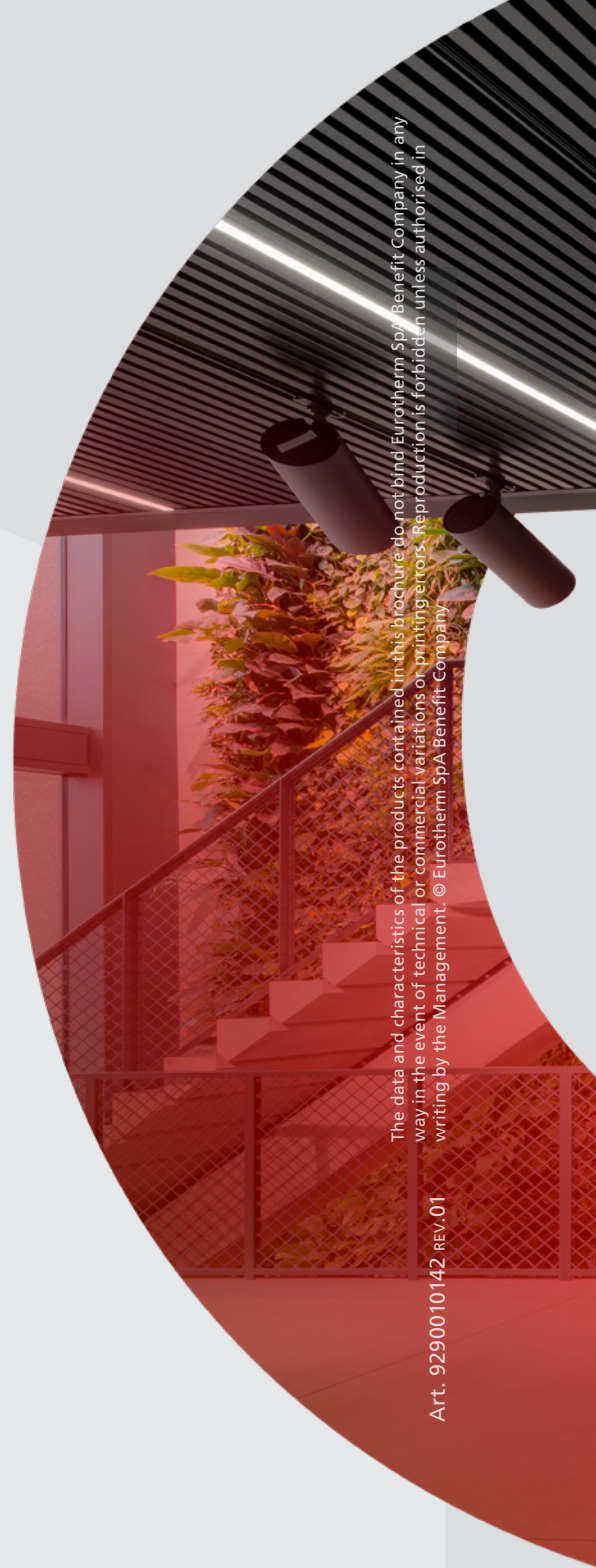

The data and characteristics of the products contained in this brochure do not bind Eurotherm SpA Benefit Company in any way in the event of technical or commercial variations or printing errors. Reproduction is forbidden unless authorised in writing by the Management. © Eurotherm SpA Benefit Company

Art. 9290010142 REV.01



Eurotherm SpA Benefit Company  
 Pillhof 91 – 39057 Bolzano – Italy  
 T +39 0471 63 55 00  
 mail@eurotherm.info



ESNA-SOA

eurotherm.info |

