



# Radiant floor systems

Underfloor radiant systems offer a complete range of applications characterised by great versatility and suited to best meet all comfort requirements in any living context.

More quality for  
the indoor **climate.**

More value for  
**well-being.**





## CERTIFICATO DI GARANZIA EUROTHERM EUROTHERM WARRANTY CERTIFICATE EUROTHERM-GARANTIEZERTIFIKAT

Eurotherm, per garantire la sicurezza e la tranquillità dei propri Clienti si è dotata delle necessarie coperture assicurative al fine di tutelare l'interesse, affidandosi a ITAS Mutua. La garanzia prevede:

- Assicurazione della Responsabilità Civile del Produttore, **senza limite di tempo, su tutti i prodotti e per l'intera durata contrattuale assicurativa**, per difetti originari di produzione, assemblaggio ed progettazione, istruzione, imballaggio, contro i danni involontariamente cagionati a Terzi. I massimali assicurati sono i seguenti:  
per sinistro € **10.000.000,00**
- Assicurazione della responsabilità Civile dell'Attività, contro Terzi e su tutti i lavori di installazione e installazione effettuati da personale specializzato Eurotherm. I massimali assicurati sono i seguenti:  
per sinistro, limite per persona e limite per danni a cose € **10.000.000,00**  
Copertura valida per segnalazione sinistro entro 24 mesi da messa in pressione con procedura di impianto.

ITAS garantisce quindi contro i danni sopra descritti fino alla concorrenza dei massimali indicati nelle condizioni assicurative allegate e nell'ambito delle rispettive condizioni contrattuali di assicurazione. La garanzia vale in tutto il mondo escluso USA/CAN/MEX.

To guarantee our Clients' safety and peacefulness, Eurotherm has entered into the proper insurance contracts with ITAS Mutua in order to protect our clients' interest. The warranty includes:

- A product liability insurance, **without any temporal limitation, on all products and throughout the entire duration of the contract**, for flaws due to imperfect production, assembly and/or planning, instruction and packaging against damages accidentally caused to Third parties. The covered limit of liability are:  
per accident: € **10.000.000,00**
- A business liability insurance against Third parties and on all the maintenance and repair works fulfilled by Eurotherm expert staff. The covered limit of liability are:  
per accident, limit per person and limit per damage to goods: € **10.000.000,00**  
The coverage is valid whether the accident is alerted within 24 months from the pressure test or subsequent tightness test.

Hence, ITAS guarantees against the above-described damages within the limits laid down in the attached insurance certifications and within the consequent insurance's terms and conditions. The guarantee is valid also in USA/CAN/MEX.

Um die Sicherheit und Zufriedenheit seiner Kunden zu garantieren, hat Eurotherm einen Versicherungsgesellschaft ITAS Mutua in notwendigen Fällen mit ITAS Mutua abgeschlossen. Die Garantie umfasst wie folgt:

- **Unbefristete Haftpflichtversicherung, für alle Produkte und für die gesamte Dauer des Versicherungsjahres**, für Fabrikationsfehler, Montage- und/oder Konstruktionsfehler, Fehler in der Anleitung oder Verpackung gegenüber Dritten. Die Obergrenzen sind wie folgt:  
€ **10.000.000,00** pro Schadensfall
- Haftpflichtversicherung gegenüber Dritte und für Wartungs- und Reparaturarbeiten, die von Spezialisten von Eurotherm durchgeführt werden.

## Lifetime Warranty

Eurotherm radiant systems are lifelong guaranteed by ITAS Assicurazioni. Eurotherm extends the guarantee to the entire lifetime of the radiant system against unintentional damage caused to third parties resulting from manufacturing, assembly and/or design defects.



# Guide to choosing a system

		Large areas	High efficiency	Low thickness and low inertia	Acoustic containment	Industrial
		<i>Residential and tertiary</i>	<i>Residential and villas</i>	<i>Renovation and tertiary</i>	<i>Residential and tertiary</i>	<i>Warehouses, halls and gyms</i>
Thermoformed knob boards	<b>Euroflex TF Plus Lambda</b> page 10	✓	✓			
	<b>Euroflex TF Plus</b> page 12	✓	✓			
	<b>Euroflex TF Acoustic</b> page 14	✓			✓	
	<b>Euroflex</b> page 16	✓		✓		
	<b>Euroflex TFS mini</b> page 38	✓				✓
Hot-melt flat boards	<b>Eurosuper</b> page 18		✓	✓		
	<b>Europlus-Lambda</b> page 20	✓	✓			
	<b>Europlus-Silentium</b> page 22	✓	✓		✓	
	<b>Europlus-Fast</b> page 24	✓	✓			
	<b>Europlus-Flex</b> page 26	✓	✓			
	<b>Europlus-Acoustic</b> page 28	✓		✓		
	<b>Ecoplus</b> page 30	✓			✓	
	<b>Europlus-Ten</b> page 40		✓		✓	
Industrial and special systems	<b>Eurogrid</b> page 32	✓		✓		✓
	<b>Eurobarra</b> page 34					✓
	<b>Euroindustry</b> page 36					✓
	<b>Euroslim</b> page 42		✓	✓		

The table suggests which system is most suitable for use in a specific case (e.g. large areas, residential, etc.). All Eurotherm systems are however compatible with any building application.



## Guaranteed comfort in every environment

Eurotherm underfloor heating systems offer versatile solutions for living comfort, suitable for any context.

The result of advanced studies on technologies and materials, each system is designed to meet specific requirements such as thermal insulation, acoustic insulation or environmental sustainability.

**Our focus on sustainability** is confirmed by the **EPD (Environmental Product Declaration)** certification obtained for our metal ceiling radiant system and piping. This certification, issued by independent bodies, assesses the environmental impact of products throughout their life cycle, from production to disposal.

Eurotherm systems operate at low temperatures, reducing consumption and increasing energy savings, with high efficiencies in both heating and cooling. **Their performance is certified** by nationally and internationally recognised research institutes and universities, guaranteeing optimal comfort.

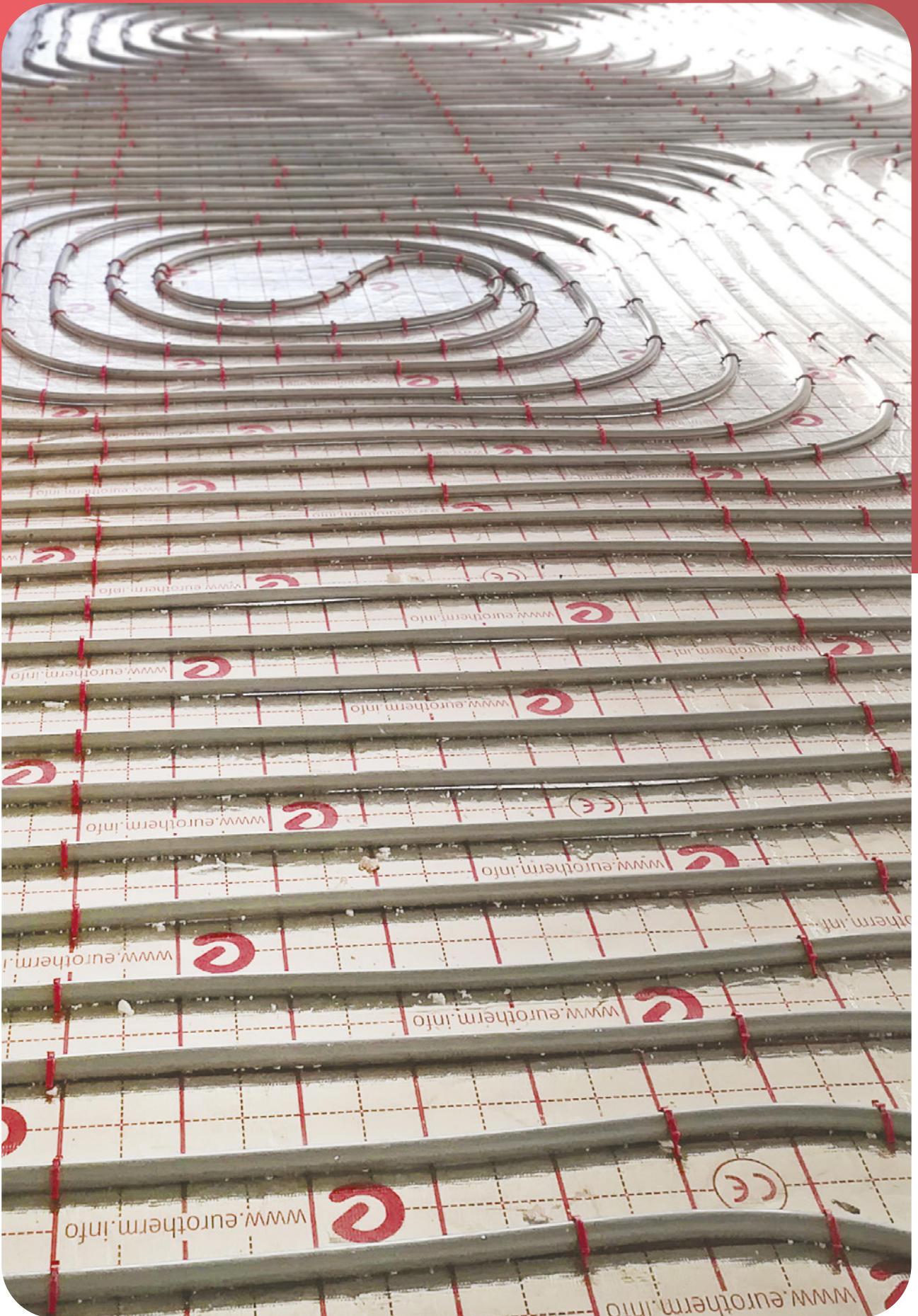

## The **natural** climate

Radiant underfloor heating systems are supplied at a low temperature, allowing considerable energy savings in terms of reduced running consumption. Heat is spread evenly throughout the room and thermal comfort is achieved at a temperature of 19 °C instead of the 21 °C of a radiator system.

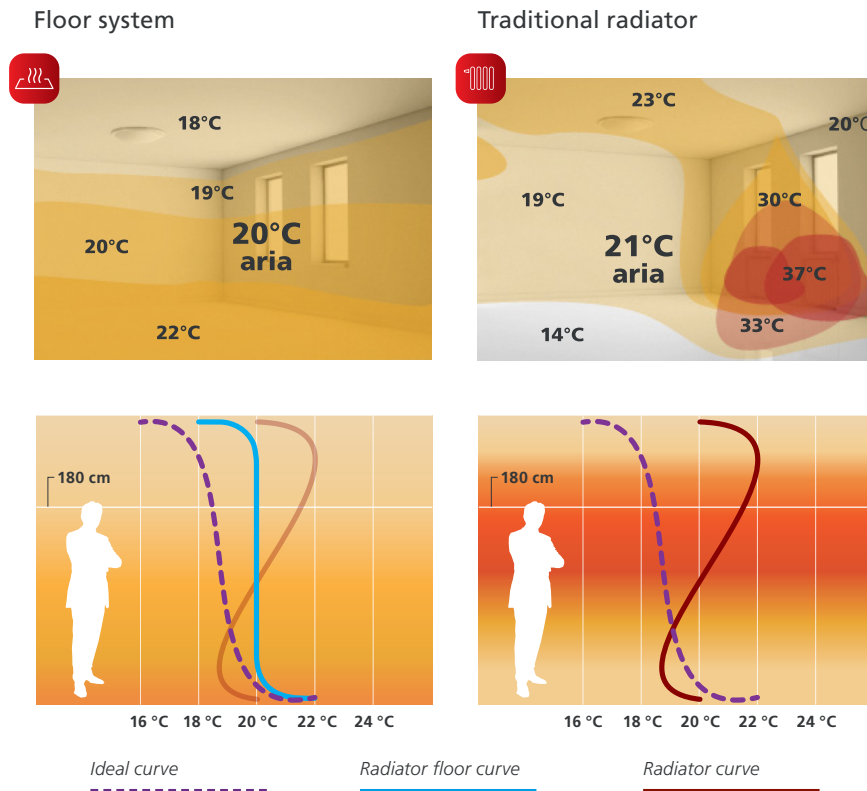

## Radiant **standards**

### Insulation requirements according to EN 1264-4:2021

System insulation – Minimum thermal resistance of the insulation layers of the system under the pipes of the heating/cooling installations:

	Underneath or adjacent heated room	Unheated or non-continuously heated underlying or adjacent room or directly on the ground	Underlying or adjacent outside air temperature		
			Outdoor design temperature $\vartheta_d \geq 0$ °C	Outdoor design temperature $0$ °C > $\vartheta_d \geq -5$ °C)	Outdoor design temperature $-5$ °C > $\vartheta_d \geq -15$ °C
<b>Thermal resistance <math>R_{\lambda,ins}</math> (m<sup>2</sup> K)/W</b>	0.75	1.25	1.25	1.50	2.00

While for new buildings the thermal resistance value must only be provided by the insulation, **for renovations the  $R_{\lambda,ins}$  value can be determined by taking into account the actual thermal resistance of the building structure, including the insulation layers.**

With the 2021 revision, a new reference for calculating the insulation thickness for embossed systems (type A and C) is introduced. As of 2021, **only the flat part of the board (without nobs) must be considered for the calculation of the thermal resistance.**

# Q & A

## 5 simple answers on the radiant system

### **How does an underfloor system work?**

A radiant system is a system that allows a room to be heated or cooled by means of radiation from a surface by passing water through pipes arranged in a circuit. With the hypocaust (hypocaustum), the ancient Romans had already invented a system that, by circulating hot air inside cavities under the floor, could heat the room from below. In more recent times, using the Roman model, the modern radiant system was created, employing a copper coil in which high-temperature water circulated. Today the radiant system has evolved considerably both in technology (intelligent regulation systems) and in the use of materials. In fact, the obsolete and very expensive copper pipes have been replaced by cheaper and better performing ones in PE-RT, plastic, equipped with an oxygen barrier in which water flows at a low temperature (29-32 °C) which significantly increases energy savings and avoids circulation problems in the lower limbs.

### **How reliable is a radiant system over time?**

All components of a radiant system are designed and tested for durability and long life. All insulation is manufactured to be unaffected and the pipework itself is guaranteed for at least 50 years. If not for errors during installation or an accidental puncture, the radiant system cannot suffer any leakage. Should this unfortunate event occur, a simple thermographic survey can quickly identify the damage and repair it. Due to the high quality of construction and workmanlike installation, Eurotherm guarantees its radiant systems without time limitation for original defects, manufacturing, assembly and/or design, against unintentional damage caused to third parties.

### **Which floor covering is compatible with the floor system?**

All coverings are compatible with radiant floor systems as long as the thermal efficiency is not compromised (thermal resistance must not exceed 0.15 m<sup>2</sup> K/W). Therefore, the type of covering and the thickness laid determine the lower or higher energy efficiency. For example, materials such as marble, ceramics, granite, due to the ease with which they conduct heat, are better suited to the covering of a radiant system. However, it is a good idea to check which type of material is most suitable for covering and how it should be applied.





### **Is it possible to regulate the temperature of the system?**

It is possible to regulate the system temperature by time bands, room by room, ensuring ideal comfort in every room and avoiding unnecessary energy waste, such as at night when the temperature can be significantly lowered. With its intelligent adjustments, Eurotherm ensures complete control over the radiant system, optimising its performance.

### **Can the radiant floor system cool?**

Unlike conventional radiators, the underfloor system can perform the cooling function during the summer. With radiant cooling, annoying jets of cold air are avoided, providing excellent comfort even in summer. To avoid the possible formation of condensation, an air treatment machine is combined with the radiant system to manage room humidity.

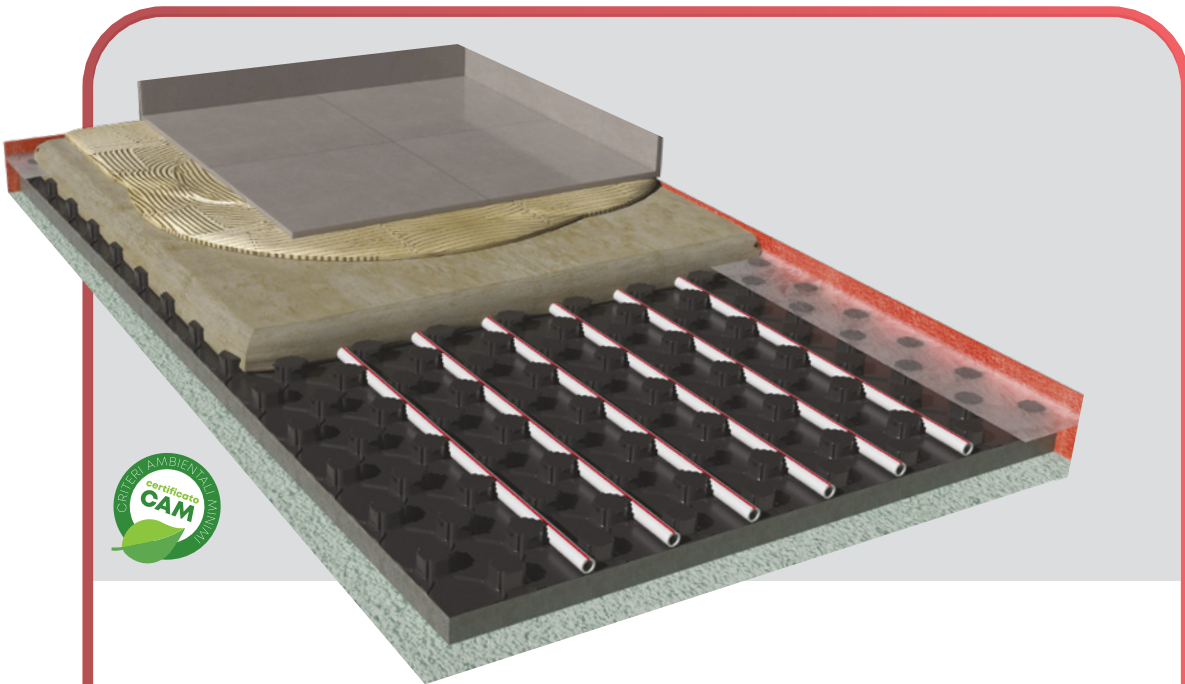

## Euroflex TF Plus Lambda

- Board with extremely resistant PS thermoformed sheeting.
- Sintered insulation panel with graphite.
- Board compatible with previous version Euroflex TF.
- Available in CAM version according to D.M. June 2022.
- Optimised embossed knobs to maximise output.

Underfloor heating and cooling system with a preformed polystyrene sheet. The system includes 3 different thicknesses that can be chosen based on the installation condition. Depending on the heat requirement, pipes with an external diameter of 14 mm to 18 mm and multiple centre distances of 5 cm can be used. The shape of the embossing has been optimised to maximise the contact area of the pipe with the screed, increase the performance of the system, allow for clipless attachment and improve the performance with regard to footfall crush. Thanks to the new embossing, the amount of material per package has increased.

The board is protected at the top by a thermoformed, waterproof PS sheeting (in accordance with UNI EN 1264-4) with a thickness of 0.6 mm, which gives the board a high degree of protection.

The insulation and its embossing are mechanically strong enough to prevent deformations on site. The system includes a perimeter strip of closed-cell polyethylene foam with a polyethylene sheet of a suitable height for the chosen insulation, which can be lifted and has a self-adhesive band on the back at full height; reaction to fire (EPS insulation) Class E (EN 13501-1).

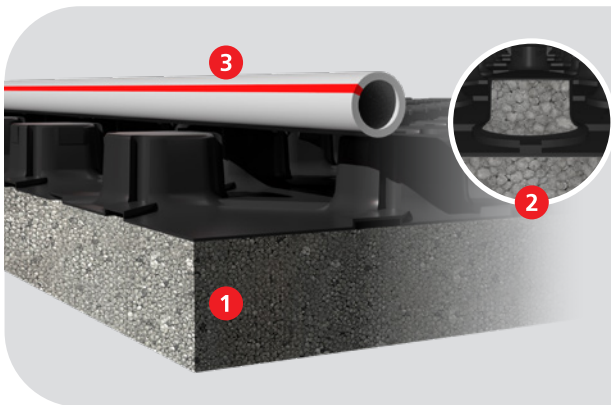

### System Composition

1. Sintered EPS insulation sheet with graphite.
2. Thermoformed PS sheet 0.6 mm thick.
3. 5-layer MidiX Plus pipe.

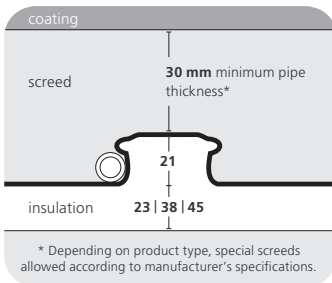

<b>Insulation</b>	EPS sintered with GRAPHITE
$\lambda_D$	0.030 W/mK (EPS + graphite)
<b>Thickness</b>	23/44   38/59   45/66 mm
<b>Pipe</b>	14 x 2   16 x 2   17 x 2   18 x 2 mm
<b>Pipe spacing</b>	5   10   15   20 cm

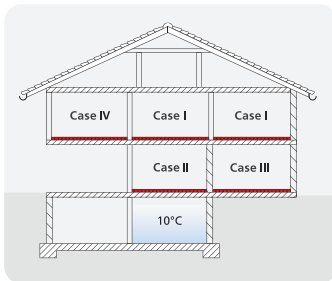

### Thicknesses in accordance with EN 1264:2021

Case I	23 mm
Case II and III	38 mm
Case IV [T external ≥ 0° C]	38 mm
Case IV [-5° C ≤ T external < 0° C]	38 mm
Case IV [-15° C ≤ T external < -5° C]	45 mm

### System yields in W/m<sup>2</sup>

Ambient temperature 20 °C, Δt = 5 K | Ambient temperature 26 °C, Δt = 2 K |  $R_{\lambda,B}$  [m<sup>2</sup> K/W] = thermal resistance of the coating.

System yields in winter															
T flow water [°C]				28		32		36		40		44		48	
pipe spacing [cm]		$R_{\lambda,B}$ [m <sup>2</sup> K/W]		10	15	10	15	10	15	10	15	10	15	10	15
coating	ceramic	0.01		30	25	52	44	73	63	95	81	117	100	139	118
	wood 10 mm	0.06		23	21	40	35	57	50	74	65	91	80	109	95
	wood 16 mm	0.1 (standard)		20	18	34	31	49	44	63	57	78	69	92	82
	wood 20 mm	0.125		18	16	31	28	45	40	58	52	71	64	84	76

System yields in summer															
T flow water [°C]				14		15		16		17		18		19	
pipe spacing [cm]		$R_{\lambda,B}$ [m <sup>2</sup> K/W]		10	15	10	15	10	15	10	15	10	15	10	15
coating	ceramic	0.01		-44	-39	-40	-35	-36	-32	-32	-28	-28	-25	-24	-21
	wood 10 mm	0.06		-35	-32	-32	-29	-29	-26	-26	-23	-23	-20	-19	-17
	wood 16 mm	0.1 (standard)		-33	-30	-30	-27	-27	-25	-24	-22	-21	-19	-18	-16
	wood 20 mm	0.125		-33	-30	-30	-27	-27	-24	-24	-22	-21	-19	-18	-16

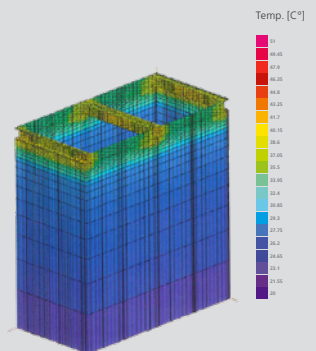

Yields determined by numerical simulations.

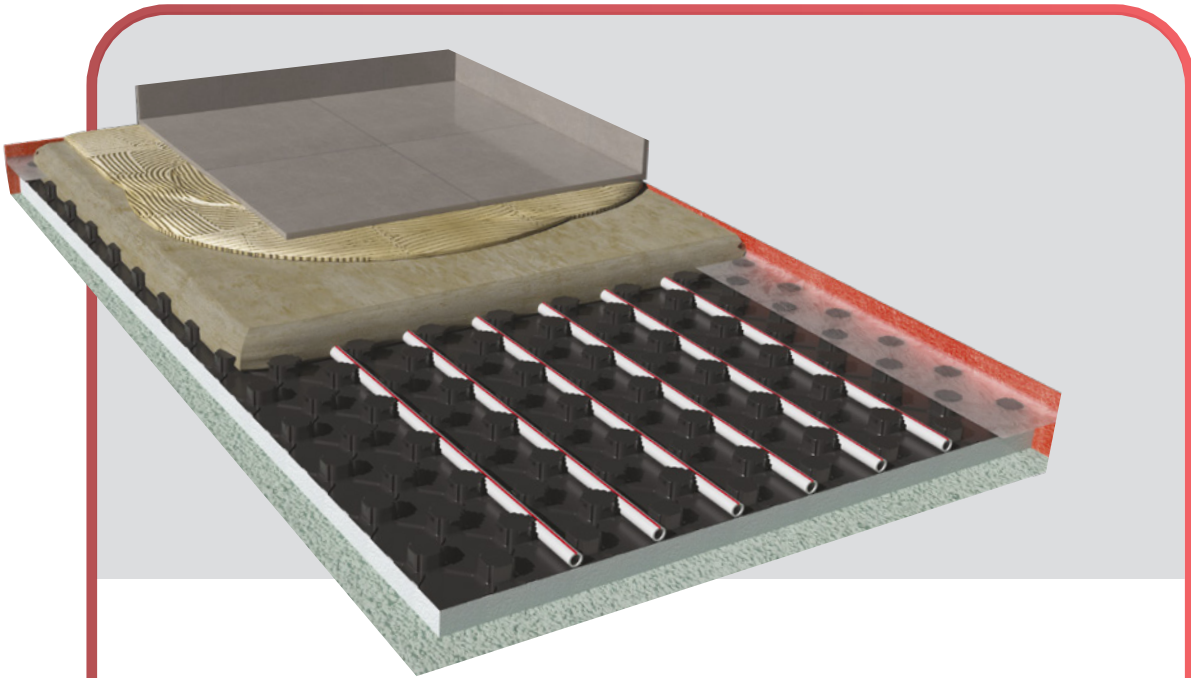

## Euroflex TF Plus

- Board with extremely resistant PS thermoformed sheeting.
- High resistance to deformation.
- Board compatible with previous version Euroflex TF.
- Optimised embossed knobs to maximise output.

Underfloor heating and cooling system with a preformed polystyrene sheet. The system includes 4 different thicknesses that can be chosen based on the installation condition. Depending on the heat requirement, pipes with an external diameter of 14 mm to 18 mm and multiple centre distances of 5 cm can be used. The shape of the embossing has been optimised to maximise the contact area of the pipe with the screed, increase the performance of the system, allow it to be attached without the use of clips, and improve the performance with regard to footfall crush.

Thanks to the new embossing, the amount of material per package has increased. The board is protected on the top by a thermoformed, waterproof PS sheeting (required by UNI EN 1264-4) with a thickness of 0.6 mm, which gives the insulation board and its embossing a mechanical resistance that prevents deformations. The system includes a perimeter strip of closed-cell polyethylene foam with a polyethylene sheet of a suitable height for the chosen insulation, which can be lifted and has a self-adhesive band on the back at full height; reaction to fire (EPS insulation) Class E (EN 13501-1).

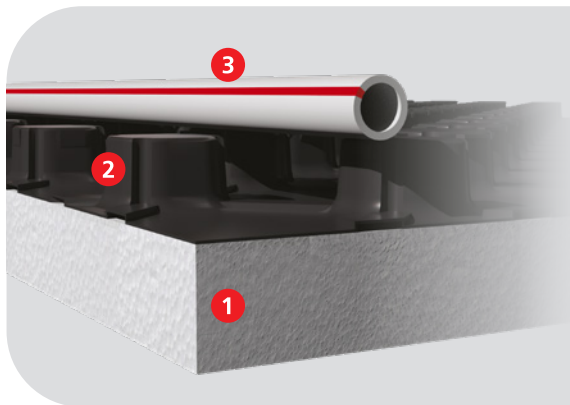

## System Composition

1. EPS insulation sheet.
2. Thermoformed PS sheet 0.6 mm thick.
3. 5-layer MidiX Plus pipe.

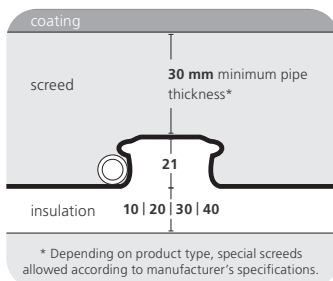

<b>Insulation</b>	EPS
$\lambda_D$	0.034 W/mK
<b>Thickness</b>	10/31   20/41   30/51   40/61 mm
<b>Pipe</b>	14 x 2   16 x 2   17 x 2   18 x 2 mm
<b>Pipe spacing</b>	5   10   15   20 cm

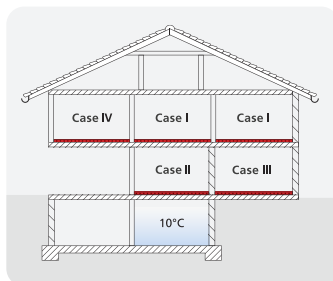

### Thicknesses in accordance with EN 1264:2021

Case I	30 mm
Case II and III	40 mm
Case IV [T external $\geq 0^\circ\text{C}$ ]	40 mm
Case IV [-5° C $\leq$ T external < 0° C]	
Case IV [-15° C $\leq$ T external < -5° C]	

### System yields in W/m<sup>2</sup>

Ambient temperature 20 °C,  $\Delta t = 5\text{ K}$  | Ambient temperature 26 °C,  $\Delta t = 2\text{ K}$  |  $R_{\lambda,B}$  [m<sup>2</sup> K/W] = thermal resistance of the coating.

System yields in winter															
T flow water [°C]				28		32		36		40		44		48	
pipe spacing [cm]		$R_{\lambda,B}$ [m <sup>2</sup> K/W]		10	15	10	15	10	15	10	15	10	15	10	15
coating	ceramic	0.01		30	25	52	44	73	63	95	81	117	100	139	118
	wood 10 mm	0.06		23	21	40	35	57	50	74	65	91	80	109	95
	wood 16 mm	0.1 (standard)		20	18	34	31	49	44	63	57	78	69	92	82
	wood 20 mm	0.125		18	16	31	28	45	40	58	52	71	64	84	76

System yields in summer															
T flow water [°C]				14		15		16		17		18		19	
pipe spacing [cm]		$R_{\lambda,B}$ [m <sup>2</sup> K/W]		10	15	10	15	10	15	10	15	10	15	10	15
coating	ceramic	0.01		-44	-39	-40	-35	-36	-32	-32	-28	-28	-25	-24	-21
	wood 10 mm	0.06		-35	-32	-32	-29	-29	-26	-26	-23	-23	-20	-19	-17
	wood 16 mm	0.1 (standard)		-33	-30	-30	-27	-27	-25	-24	-22	-21	-19	-18	-16
	wood 20 mm	0.125		-33	-30	-30	-27	-27	-24	-24	-22	-21	-19	-18	-16

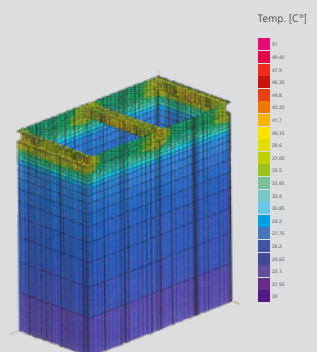

Yields determined by numerical simulations.

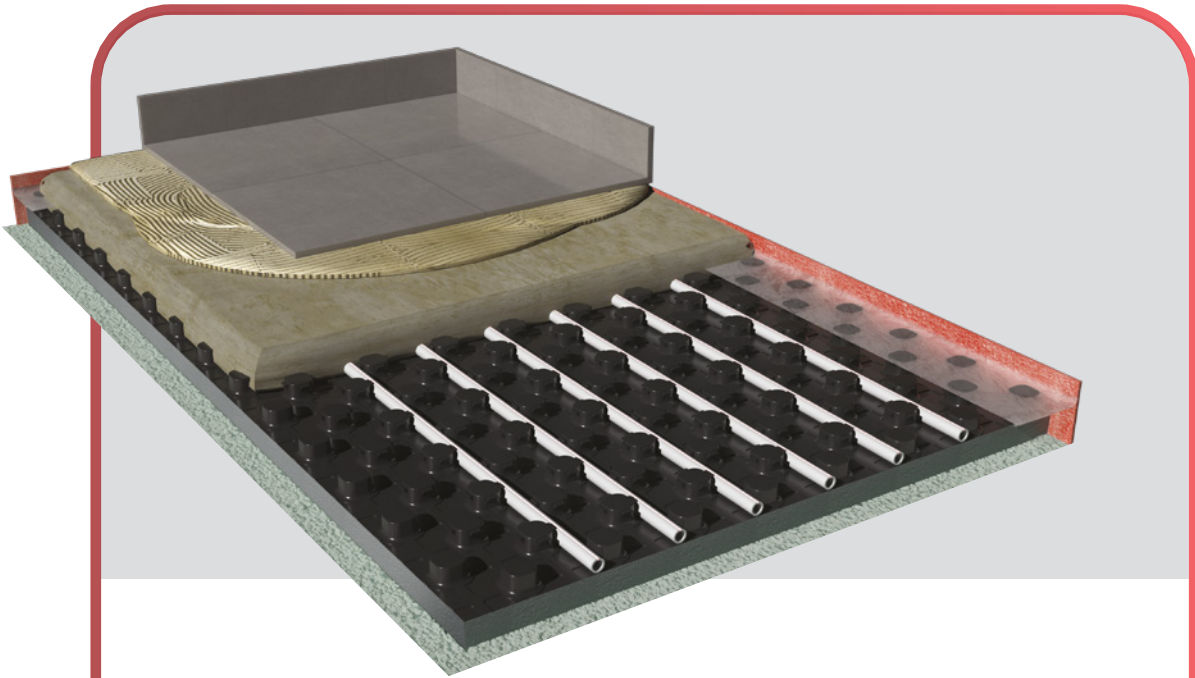

## Euroflex TF Acoustic

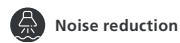

- Board with extremely resistant PS thermoformed sheeting.
- Sound pressure level attenuation of 29 dB.
- High resistance to deformation.
- Quick and easy pipe-laying.

Underfloor heating and cooling system with a preformed expanded polystyrene sheet protected on the top by a black PS interlocking thermoformed film 0.8 mm thick (UNI EN 1264-4), protecting the insulation and embossing arranged to allow the laying of piping with an external diameter from 16 mm to 18 mm with spacing in multiples of 5 cm; declared thermal conductivity  $\lambda_D$  equal to 0.040 W/mK according to UNI EN 13163; compressibility level CP2 (deformation of 2 mm under compression of 5.0 kPa); reaction to fire (EPS insulation) Euroclass E (EN 13501-1); declared thermal resistance RD equal to 0.80 m<sup>2</sup> K/W; dynamic rigidity  $S' = 20$  MN/m<sup>3</sup>; sound pressure level attenuation  $\Delta L_w = 29$  dB (UNI EN 12354- 2) with a surface mass of 110 kg/m<sup>2</sup>; reaction to fire (EPS insulation) Class E (EN 13501-1).

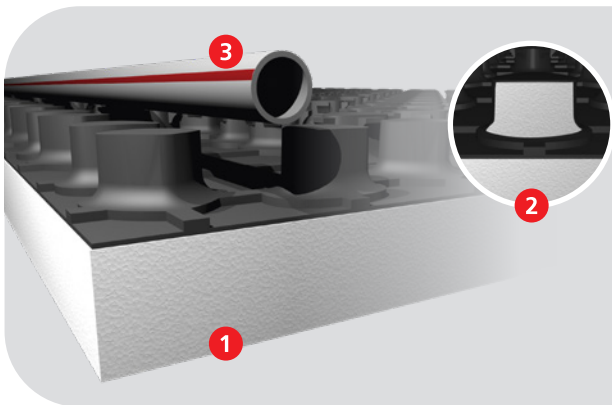

### System Composition

1. EPS insulation sheet.
2. Thermoformed PS sheet 0.8 mm thick.
3. 5-layer MidiX Plus pipe.

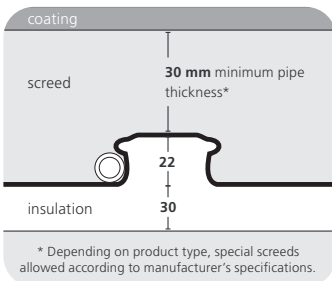

<b>Insulation</b>	EPS
$\lambda_D$	0.040 W/mK
<b>Thickness</b>	30/52 mm
<b>Acoustics</b>	$\Delta L_w = 29$ dB
<b>Pipe</b>	14 x 2   16 x 2   17 x 2   18 x 2 mm
<b>Pipe spacing</b>	5   10   15   20 cm

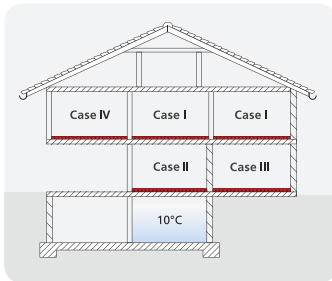

### Thicknesses in accordance with EN 1264:2021

Case I	30 mm
Case II and III	
Case IV [T external ≥ 0° C]	
Case IV [-5° C ≤ T external < 0° C]	
Case IV [-15° C ≤ T external < -5° C]	

### System yields in W/m<sup>2</sup>

Ambient temperature 20 °C, Δt = 5 K | Ambient temperature 26 °C, Δt = 2 K |  $R_{\lambda,B}$  [m<sup>2</sup>K/W] = thermal resistance of the coating.

System yields in winter															
T flow water [°C]				28		32		36		40		44		48	
pipe spacing [cm]		$R_{\lambda,B}$ [m <sup>2</sup> K/W]		10	15	10	15	10	15	10	15	10	15	10	15
coating	ceramic	0.01		30	25	52	44	73	63	95	81	117	100	139	118
	wood 10 mm	0.06		23	21	40	35	57	50	74	65	91	80	109	95
	wood 16 mm	0.1 (standard)		20	18	34	31	49	44	63	57	78	69	92	82
	wood 20 mm	0.125		18	16	31	28	45	40	58	52	71	64	84	76

System yields in summer															
T flow water [°C]				14		15		16		17		18		19	
pipe spacing [cm]		$R_{\lambda,B}$ [m <sup>2</sup> K/W]		10	15	10	15	10	15	10	15	10	15	10	15
coating	ceramic	0.01		-44	-39	-40	-35	-36	-32	-32	-28	-28	-25	-24	-21
	wood 10 mm	0.06		-35	-32	-32	-29	-29	-26	-26	-23	-23	-20	-19	-17
	wood 16 mm	0.1 (standard)		-33	-30	-30	-27	-27	-25	-24	-22	-21	-19	-18	-16
	wood 20 mm	0.125		-33	-30	-30	-27	-27	-24	-24	-22	-21	-19	-18	-16

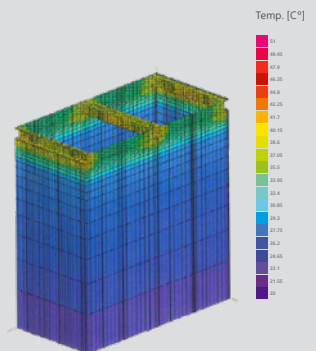

Yields determined by numerical simulations.

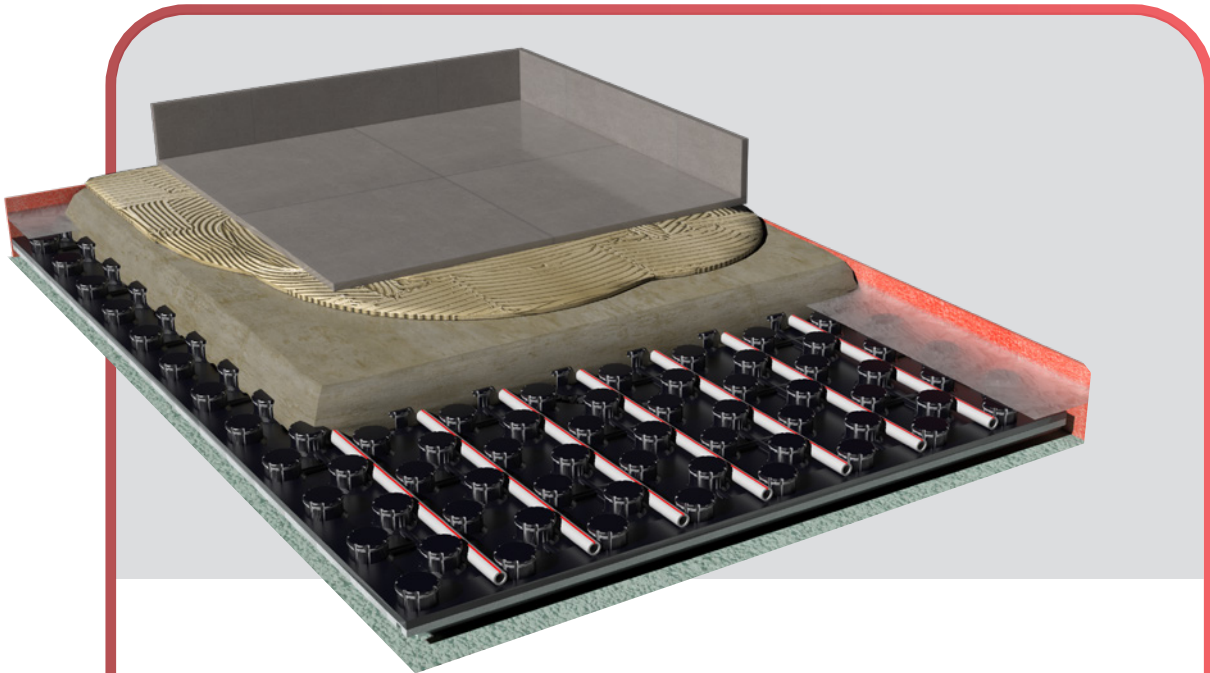

## Euroflex

- EPS board laminated with black protective sheeting.
- Interlocking to eliminate thermal bridges between boards.

Underfloor heating and cooling system comprising a preformed polystyrene sheet with declared thermal conductivity  $\lambda_D$  equal to 0.035 W/mK (UNI EN 13163), protected on the top by a black heat-coupled protective film (UNI EN 1264-4). The system includes 3 different thicknesses that can be chosen based on the installation condition. Depending on the thermal requirements, it is possible to use a pipe  $\varnothing 14 \div 17$  mm and multiple centre distances of 5 cm. The insulation panel is interlocking to eliminate thermal bridges. The embrasure is designed to maximise the contact area of the pipe with the screed and increase the performance of the system. The system includes a perimeter strip in closed-cell polyethylene foam of suitable height, which can be lifted and has a self-adhesive band on the back at full height, reaction to fire (EPS insulation): class E (EN 13501-1).



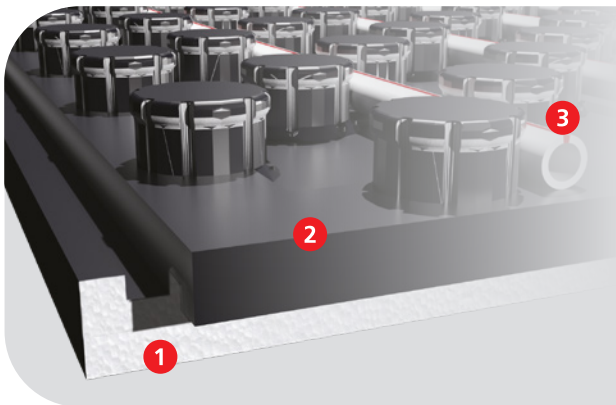

### System Composition

1. EPS insulation sheet.
2. Black protective sheet.
3. 5-layer MidiX Plus pipe.

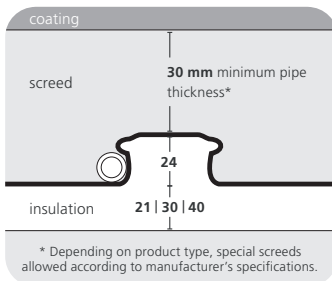

<b>Insulation</b>	EPS
$\lambda_D$	0.035 W/mK
<b>Thickness</b>	21/45   30/54   40/64 mm
<b>Pipe</b>	14 x 2   16 x 2   17 x 2 mm
<b>Pipe spacing</b>	5   10   15   20 cm

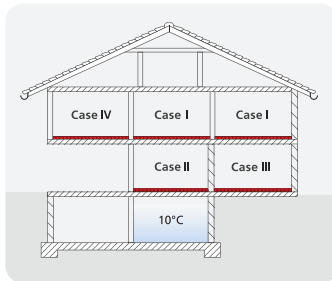

### Thicknesses in accordance with EN 1264:2021

Case I	30 mm
Case II and III	30   40 mm
Case IV [T external ≥ 0° C]	
Case IV [-5° C ≤ T external < 0° C]	
Case IV [-15° C ≤ T external < -5° C]	

### System yields in W/m<sup>2</sup>

Ambient temperature 20 °C, Δt = 5 K | Ambient temperature 26 °C, Δt = 2 K |  $R_{\lambda,B}$  [m<sup>2</sup> K/W] = thermal resistance of the coating.

System yields in winter																
T flow water [°C]				28		32		36		40		44		48		
pipe spacing [cm]		$R_{\lambda,B}$ [m <sup>2</sup> K/W]	10	15	10	15	10	15	10	15	10	15	10	15	10	15
coating	ceramic	0.01	30	25	52	44	73	63	95	81	117	100	139	118		
	wood 10 mm	0.06	23	21	40	35	57	50	74	65	91	80	109	95		
	wood 16 mm	0.1 (standard)	20	18	34	31	49	44	63	57	78	69	92	82		
	wood 20 mm	0.125	18	16	31	28	45	40	58	52	71	64	84	76		

System yields in summer																
T flow water [°C]				14		15		16		17		18		19		
pipe spacing [cm]		$R_{\lambda,B}$ [m <sup>2</sup> K/W]	10	15	10	15	10	15	10	15	10	15	10	15	10	15
coating	ceramic	0.01	-44	-39	-40	-35	-36	-32	-32	-28	-28	-25	-24	-21		
	wood 10 mm	0.06	-35	-32	-32	-29	-29	-26	-26	-23	-23	-20	-19	-17		
	wood 16 mm	0.1 (standard)	-33	-30	-30	-27	-27	-25	-24	-22	-21	-19	-18	-16		
	wood 20 mm	0.125	-33	-30	-30	-27	-27	-24	-24	-22	-21	-19	-18	-16		

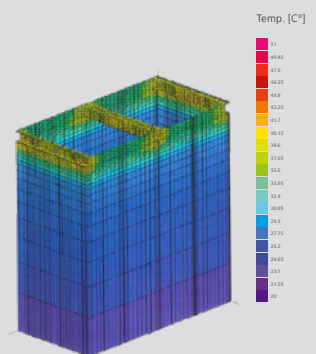

Yields determined by numerical simulations.

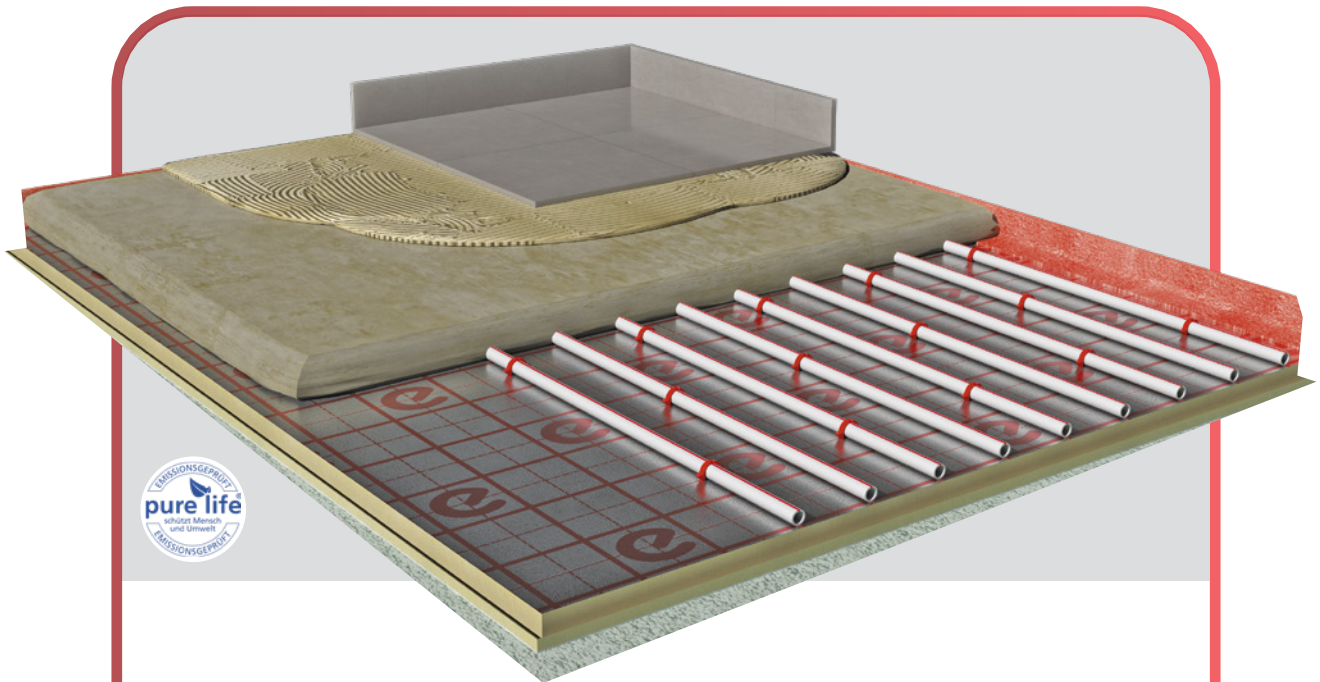

## Eurosuper

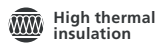

- Polyurethane provides excellent thermal performance.
- Insulation guaranteed over time thanks to the sandwich lamination with double aluminium foil.
- Pure Life certification.

Underfloor heating and cooling system with a flat 6-layer insulation board comprising a sheet of polyurethane foam between two sheets of aluminium, a pipe-stopping net, protected at the top by a plastic film (in accordance with UNI EN 1264-4) with guiding lines at a distance of 50 mm useful for laying the pipe, and at the bottom by a polyethylene sheet; the pipe attachment system includes special polyamide tacker clips. The system provides 4 different thicknesses that can be chosen based on the installation condition (minimum thermal resistance according to UNI EN 1264). The conductivity of the board is 0.023 W/mK (UNI EN 13165).

Depending on the heat requirement, a  $\varnothing$  18 pipe can be used.  $\pm$  20 mm and spacings from 5 cm to 20 cm. Certified 'pure life' insulation with low VOC emissions in the environment, produced with HCFC-free blowing agents and free of self-extinguishing HBCD and TCEP-based. The system includes a double perimeter strip of closed-cell polyethylene foam of a suitable height for the chosen insulation, which can be lifted and has a self-adhesive strip on the back; reaction to fire (EPS insulation): class E (EN13501-1).

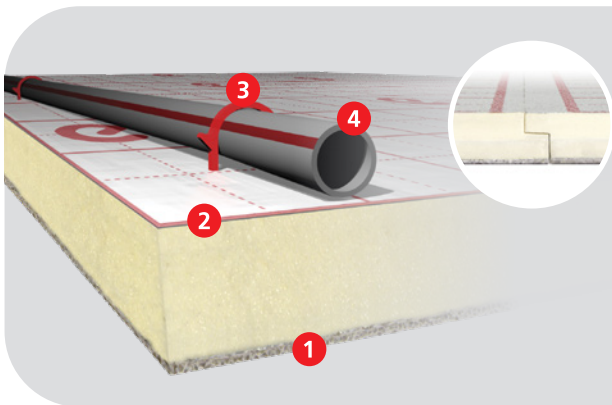

### System Composition

1. 2 mm polyurethane + polyethylene insulation sheet.
2. Alufoil double sandwich.
3. Tension-resistant clip.
4. 5-layer MidiX Plus pipe.

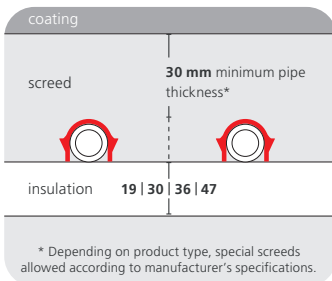

<b>Insulation</b>	Polyurethane + polyethylene
$\lambda_D$	0.023 W/mK
<b>Thickness</b>	17 + 2   28 + 2   34 + 2   45 + 2 mm
<b>Pipe</b>	18 x 2   20 x 2 mm
<b>Pipe spacing</b>	5   7.5   10   15   20 cm

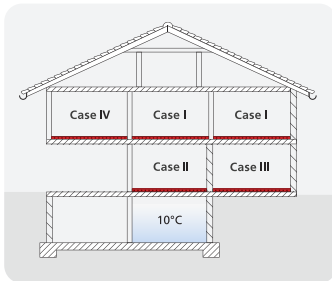

### Thicknesses in accordance with EN 1264:2021

Case I	19 mm
Case II and III	30 mm
Case IV [T external ≥ 0° C]	30 mm
Case IV [-5° C ≤ T external < 0° C]	36 mm
Case IV [-15° C ≤ T external < -5° C]	47 mm

### System yields in W/m<sup>2</sup>

Ambient temperature 20 °C, Δt = 5 K | Ambient temperature 26 °C, Δt = 2 K |  $R_{\lambda,B}$  [m<sup>2</sup> K/W] = thermal resistance of the coating.

System yields in winter															
T flow water [°C]				28		32		36		40		44		48	
pipe spacing [cm]		$R_{\lambda,B}$ [m <sup>2</sup> K/W]		10	15	10	15	10	15	10	15	10	15	10	15
coating	ceramic	0.01		32	27	55	47	78	67	101	87	124	107	147	127
	wood 10 mm	0.06		25	22	42	38	60	54	78	70	96	86	114	101
	wood 16 mm	0.1 (standard)		21	19	36	32	51	46	66	60	81	73	96	87
	wood 20 mm	0.125		19	17	33	30	46	42	60	55	74	67	88	80

System yields in summer															
T flow water [°C]				14		15		16		17		18		19	
pipe spacing [cm]		$R_{\lambda,B}$ [m <sup>2</sup> K/W]		10	15	10	15	10	15	10	15	10	15	10	15
coating	ceramic	0.01		-45	-41	-41	-37	-37	-33	-33	-30	-29	-26	-25	-22
	wood 10 mm	0.06		-37	-34	-33	-30	-30	-27	-27	-24	-23	-21	-20	-18
	wood 16 mm	0.1 (standard)		-34	-31	-31	-29	-28	-26	-25	-23	-22	-20	-19	-17
	wood 20 mm	0.125		-34	-31	-31	-28	-28	-26	-25	-23	-22	-20	-19	-17

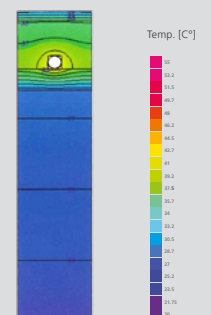

Yields determined by numerical simulations.

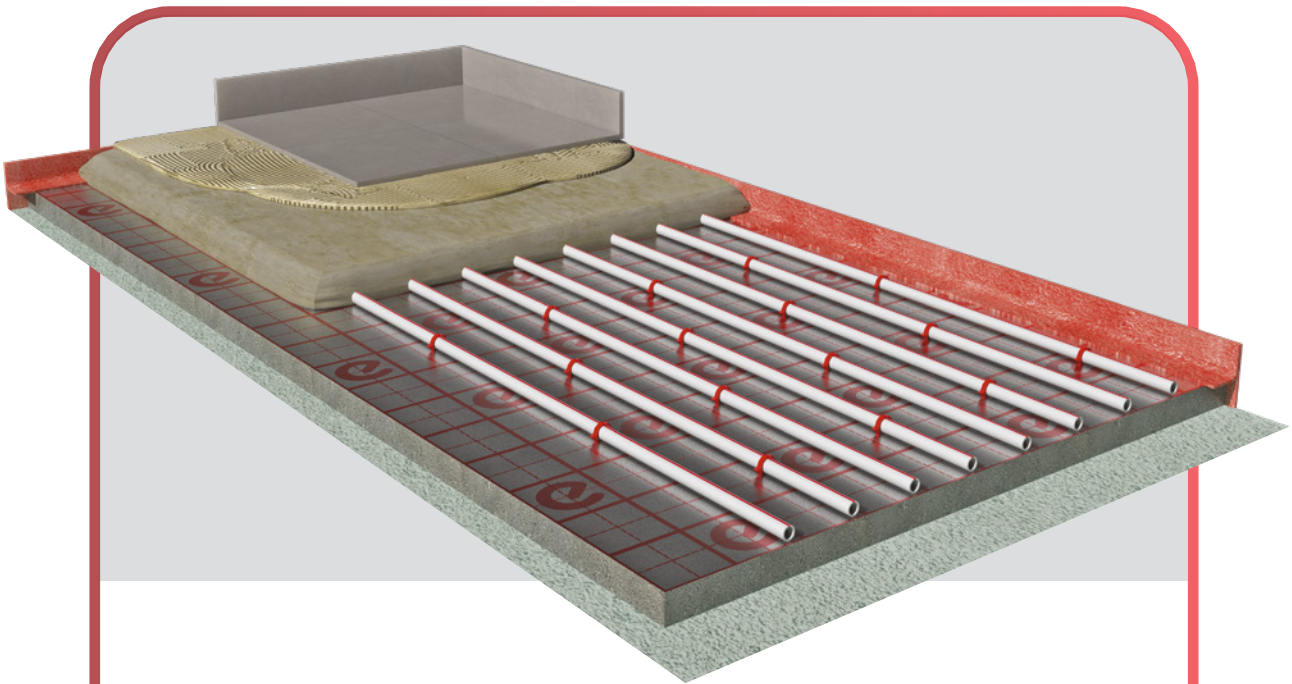

## Europlus-Lambda



- Sintered EPS insulation with graphite gives the board high thermal and mechanical performance.
- The aluminised multilayer sheet provides increased tensile strength of the clip.
- Self-gluing flap for maximum board coupling speed.

Underfloor heating and cooling system comprising a flat insulation board in sintered expanded polystyrene with graphite with declared thermal conductivity  $\lambda_D$  equal to 0.031 W/mK (UNI EN 13163), and a piping system with special tacker clips. The system includes 4 different thicknesses that can be chosen based on the installation condition (minimum thermal resistance according to UNI EN 1264). Depending on the thermal requirements, it is possible to use pipework  $\varnothing 18 \div 20$  mm and centre distances from 5 cm to 20 cm.

The insulation board is protected at the top by an aluminised multilayer sheet (UNI EN 1264-4) on which guidelines for the laying of the pipe are marked at a distance of 50 mm; the upper sheet protrudes ~20 mm and is adhesive in the protruding part so as to cover the joints between the boards during laying. The system includes a double perimeter strip of closed-cell polyethylene foam of suitable height for the chosen insulation, which can be lifted and has a self-adhesive strip on the back; reaction to fire (EPS insulation): class E (EN13501-1).

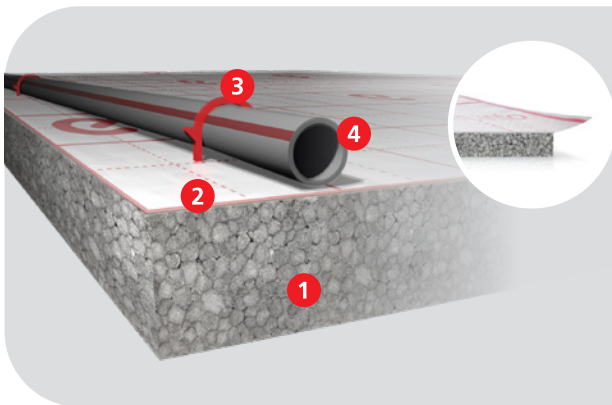

### System Composition

1. EPS insulation sheet sintered with graphite.
2. Multilayer aluminised sheet.
3. Tension-resistant clip.
4. 5-layer MidiX Plus pipe.

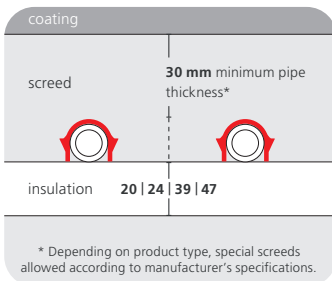

<b>Insulation</b>	EPS sintered with graphite
$\lambda_D$	0.031 W/mK
<b>Thickness</b>	20   24   39   47 mm
<b>Pipe</b>	18 x 2   20 x 2 mm
<b>Pipe spacing</b>	5   7.5   10   15   20 cm

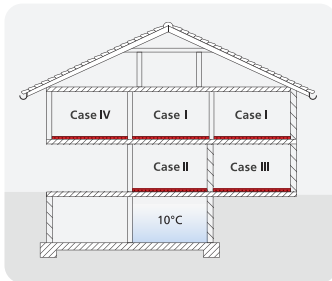

### Thicknesses in accordance with EN 1264:2021

Case I	24 mm
Case II and III	39 mm
Case IV [T external ≥ 0° C]	39 mm
Case IV [-5° C ≤ T external < 0° C]	47 mm
Case IV [-15° C ≤ T external < -5° C]	

### System yields in W/m<sup>2</sup>

Ambient temperature 20 °C, Δt = 5 K | Ambient temperature 26 °C, Δt = 2 K |  $R_{\lambda,B}$  [m<sup>2</sup> K/W] = thermal resistance of the coating.

System yields in winter															
T flow water [°C]				28		32		36		40		44		48	
pipe spacing [cm]		$R_{\lambda,B}$ [m <sup>2</sup> K/W]		10	15	10	15	10	15	10	15	10	15	10	15
coating	ceramic	0.01		32	27	55	47	78	67	101	87	124	107	147	127
	wood 10 mm	0.06		25	22	42	38	60	54	78	69	96	85	114	101
	wood 16 mm	0.1 (standard)		21	19	36	32	51	46	66	60	81	73	96	87
	wood 20 mm	0.125		19	17	33	30	46	42	60	55	74	67	88	80

System yields in summer															
T flow water [°C]				14		15		16		17		18		19	
pipe spacing [cm]		$R_{\lambda,B}$ [m <sup>2</sup> K/W]		10	15	10	15	10	15	10	15	10	15	10	15
coating	ceramic	0.01		-45	-41	-41	-37	-37	-33	-33	-30	-29	-26	-25	-22
	wood 10 mm	0.06		-37	-34	-33	-30	-30	-27	-27	-24	-23	-21	-20	-18
	wood 16 mm	0.1 (standard)		-34	-31	-31	-29	-28	-26	-25	-23	-22	-20	-19	-17
	wood 20 mm	0.125		-34	-31	-31	-28	-28	-26	-25	-23	-22	-20	-19	-17

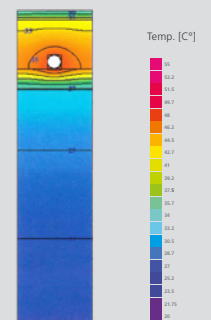

Yields determined by numerical simulations.

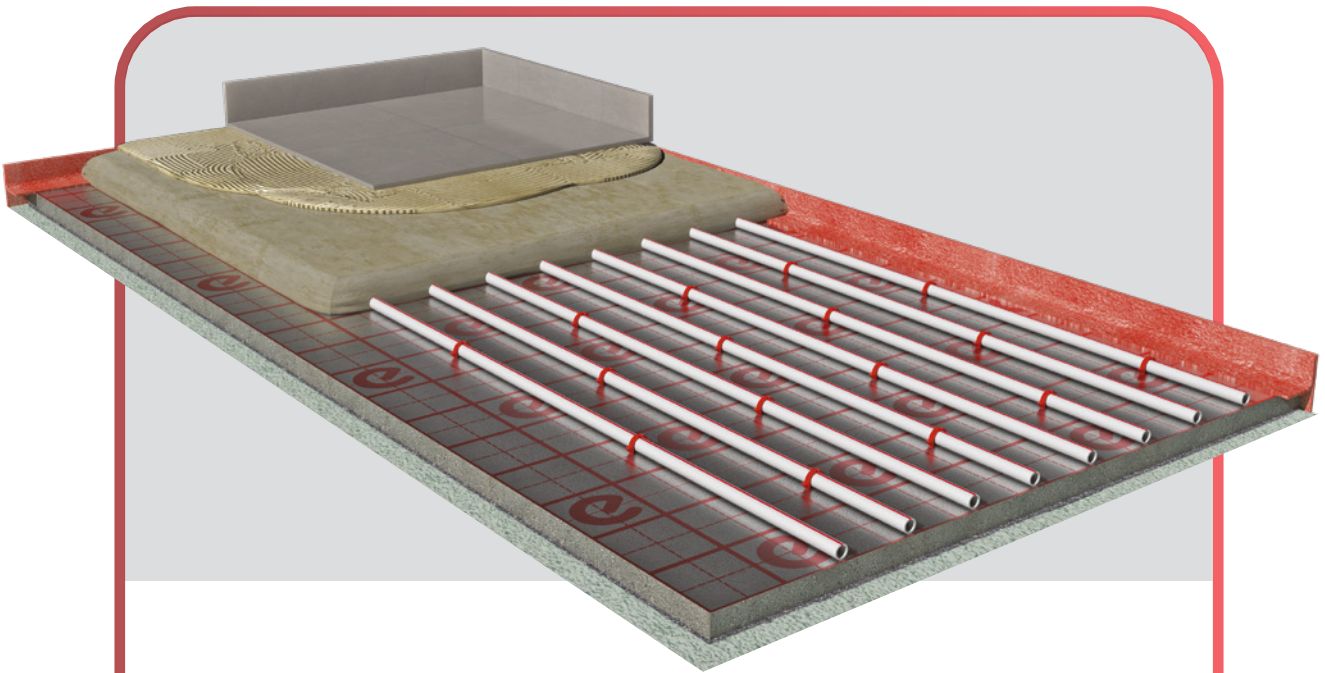

## Europlus-Silentium

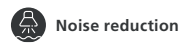

- The best noise reduction on the market.
- Impact noise attenuation of -37 dB.
- Graphite-sintered EPS gives the board high thermal and mechanical performance.
- Self-gluing flap for maximum board coupling speed.

Underfloor heating and cooling system comprising a flat insulation board in sintered expanded polystyrene with graphite with declared thermal conductivity  $\lambda_D$  equal to 0.031 W/mK (UNI EN 13163), equipped below with a sheet based on SBR rubber fibres and granules, and a pipe coupling system with special tacker clips. Depending on the heat requirement, it is possible to use a pipe with an external diameter of  $\varnothing 18 \div 20$  mm and spacing from 5 cm to 20 cm. The insulation board is protected at the top by an aluminised multi-layered sheet (UNI EN 1264-4) on which guidelines for the laying of the pipe are marked at a distance of 50 mm; the upper sheet protrudes by  $\sim 20$  mm so as to cover the joints between the boards during laying.

The board guarantees a footfall sound pressure level attenuation rating  $\Delta L_w$  greater than or equal to 37 dB according to UNI EN ISO 717-2. To allow for the greatest possible continuity of the boards and to maintain acoustic performance, there is the possibility of using Silentium granulate for filling. The system includes a double perimeter strip in closed-cell polyethylene foam of a suitable height for the chosen insulation, which can be lifted and has a self-adhesive strip on the back; reaction to fire (EPS insulation): class E (EN13501-1).

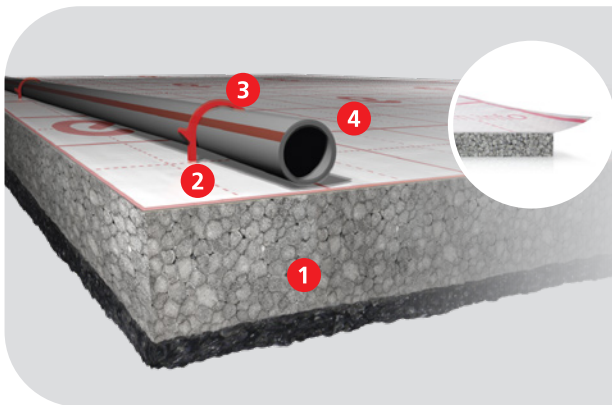

## System Composition

1. Sintered EPS insulation board with graphite and rubber fibre sheet.
2. Multilayer aluminised sheet.
3. Tension-resistant clip.
4. 5-layer MidiX Plus pipe.

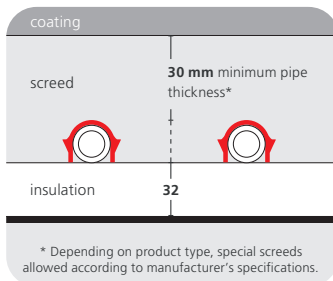

<b>Insulation</b>	Sintered EPS with graphite coupled with rubber fibre sheet
$\lambda_D$	0.031 W/mK
<b>Thickness</b>	32 mm (24 + 8)
<b>Acoustics</b>	$\Delta L_w$ 37 dB   $L_{n,w}$ 55 dB (screed and ceramic) $\Delta L_w$ 44 dB   $L_{n,w}$ 48 dB (floating parquet)
<b>Pipe</b>	18 x 2   20 x 2 mm
<b>Pipe spacing</b>	5   7.5   10   15   20 cm

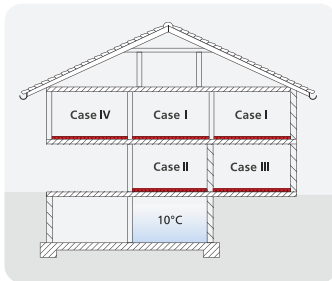

## Thicknesses in accordance with EN 1264:2021

Case I	32 mm
Case II and III	
Case IV [T external ≥ 0° C]	
Case IV [-5° C ≤ T external < 0° C]	
Case IV [-15° C ≤ T external < -5° C]	

## System yields in W/m<sup>2</sup>

Ambient temperature 20 °C,  $\Delta t = 5$  K | Ambient temperature 26 °C,  $\Delta t = 2$  K |  $R_{\lambda,B}$  [m<sup>2</sup> K/W] = thermal resistance of the coating.

System yields in winter																
T flow water [°C]				28		32		36		40		44		48		
pipe spacing [cm]		$R_{\lambda,B}$ [m <sup>2</sup> K/W]	10	15	10	15	10	15	10	15	10	15	10	15	10	15
coating	ceramic	0.01	32	27	55	47	78	67	101	87	124	107	147	127		
	wood 10 mm	0.06	25	22	42	38	60	54	78	69	96	85	114	101		
	wood 16 mm	0.1 (standard)	21	19	36	32	51	46	66	60	81	73	96	87		
	wood 20 mm	0.125	19	17	33	30	46	42	60	55	74	67	88	80		

System yields in summer																
T flow water [°C]				14		15		16		17		18		19		
pipe spacing [cm]		$R_{\lambda,B}$ [m <sup>2</sup> K/W]	10	15	10	15	10	15	10	15	10	15	10	15	10	15
coating	ceramic	0.01	-45	-41	-41	-37	-37	-33	-33	-30	-29	-26	-25	-22		
	wood 10 mm	0.06	-37	-33	-33	-30	-30	-27	-27	-24	-23	-21	-20	-18		
	wood 16 mm	0.1 (standard)	-34	-31	-31	-28	-28	-26	-25	-23	-22	-20	-19	-17		
	wood 20 mm	0.125	-34	-31	-31	-28	-28	-25	-25	-23	-22	-20	-19	-17		

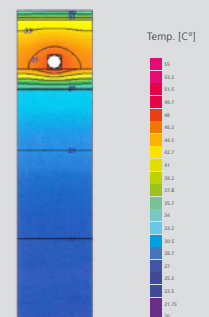

Yields determined by numerical simulations.

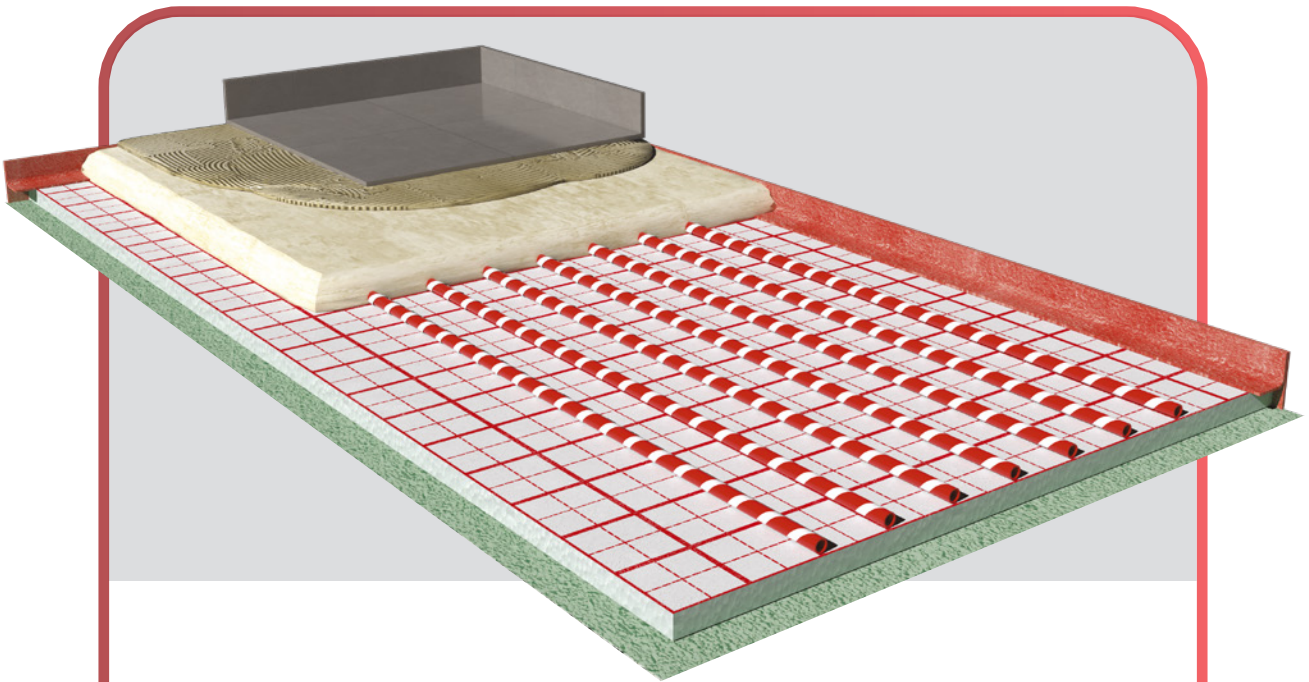

## Europlus-Fast

- Laying the pipe without the use of clips and tools.
- Possibility of easily repositioning the pipe.
- Quick and easy installation.
- Self-gluing flap for maximum board coupling speed.

Europlus-Fast expanded polystyrene insulation board, protected at the top by a Velcro sheeting on which are marked at a distance of 50 mm guidelines for the laying of the 15 mm external diameter piping with a special glued spiral tape, equipped with micro hooks for rapid hooking; declared thermal conductivity  $\lambda_D$  0.034 W/mK (UNI EN 13163, UNI EN 12667); supplied in sheets for 20/30 mm and 45 mm thicknesses; the upper sheeting of the board protrudes ~20 mm on the long side, and on the opposite side is provided with an adhesive strip to allow coupling and cover the joints of the sheets during laying. Reaction to fire (EPS insulation): class E (EN13501-1).



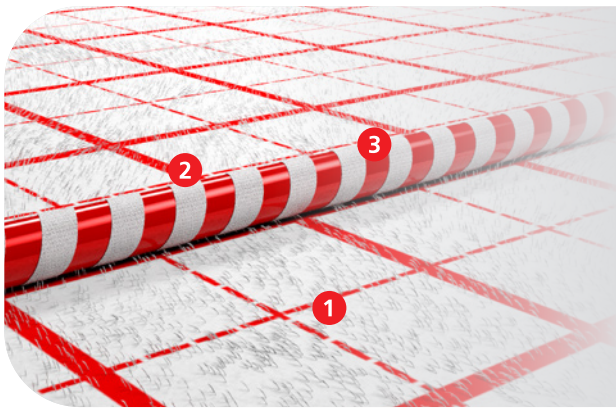

### System Composition

1. Velcro-coated sheet.
2. Micro-hole coating.
3. 5-layer MidiX Plus Fast pipe.

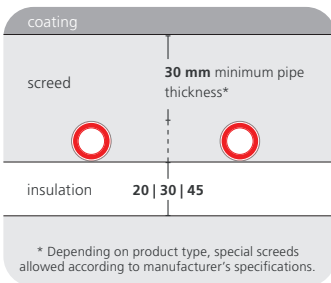

<b>Insulation</b>	EPS
$\lambda_D$	0.034 W/mK
<b>Thickness</b>	20   30   45 mm
<b>Pipe</b>	15 x 1.5 mm
<b>Pipe spacing</b>	5   7.5   10   15   20 cm

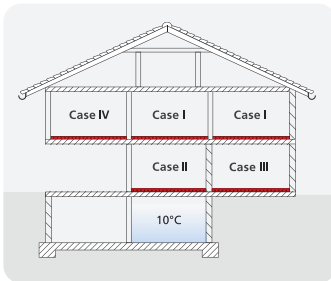

### Thicknesses in accordance with EN 1264:2021

Case I	30 mm
Case II and III	45 mm
Case IV [T external $\geq 0^\circ$ C]	45 mm
Case IV [-5° C $\leq$ T external < 0° C]	
Case IV [-15° C $\leq$ T external < -5° C]	

### System yields in W/m<sup>2</sup>

Ambient temperature 20 °C,  $\Delta t = 5$  K | Ambient temperature 26 °C,  $\Delta t = 2$  K |  $R_{\lambda,B}$  [m<sup>2</sup> K/W] = thermal resistance of the coating.

System yields in winter															
T flow water [°C]				28		32		36		40		44		48	
pipe spacing [cm]		$R_{\lambda,B}$ [m <sup>2</sup> K/W]		10	15	10	15	10	15	10	15	10	15	10	15
coating	ceramic	0.01		31	26	56	47	81	68	106	89	130	109	154	130
	wood 10 mm	0.06		24	20	43	37	61	53	81	70	99	86	118	102
	wood 16 mm	0.1 (standard)		20	18	36	32	52	47	68	60	83	74	99	87
	wood 20 mm	0.125		18	16	33	29	47	42	62	55	76	68	90	80

System yields in summer															
T flow water [°C]				14		15		16		17		18		19	
pipe spacing [cm]		$R_{\lambda,B}$ [m <sup>2</sup> K/W]		10	15	10	15	10	15	10	15	10	15	10	15
coating	ceramic	0.01		-48	-42	-44	-38	-39	-34	-35	-31	-31	-27	-26	-23
	wood 10 mm	0.06		-39	-35	-36	-32	-32	-29	-29	-25	-25	-22	-22	-19
	wood 16 mm	0.1 (standard)		-34	-31	-31	-28	-28	-25	-25	-22	-22	-20	-19	-17
	wood 20 mm	0.125		-32	-29	-29	-26	-26	-24	-23	-21	-20	-18	-17	-16

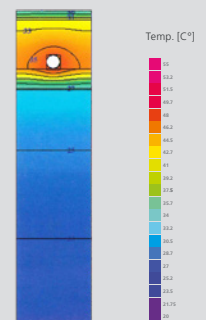

Yields determined by numerical simulations.

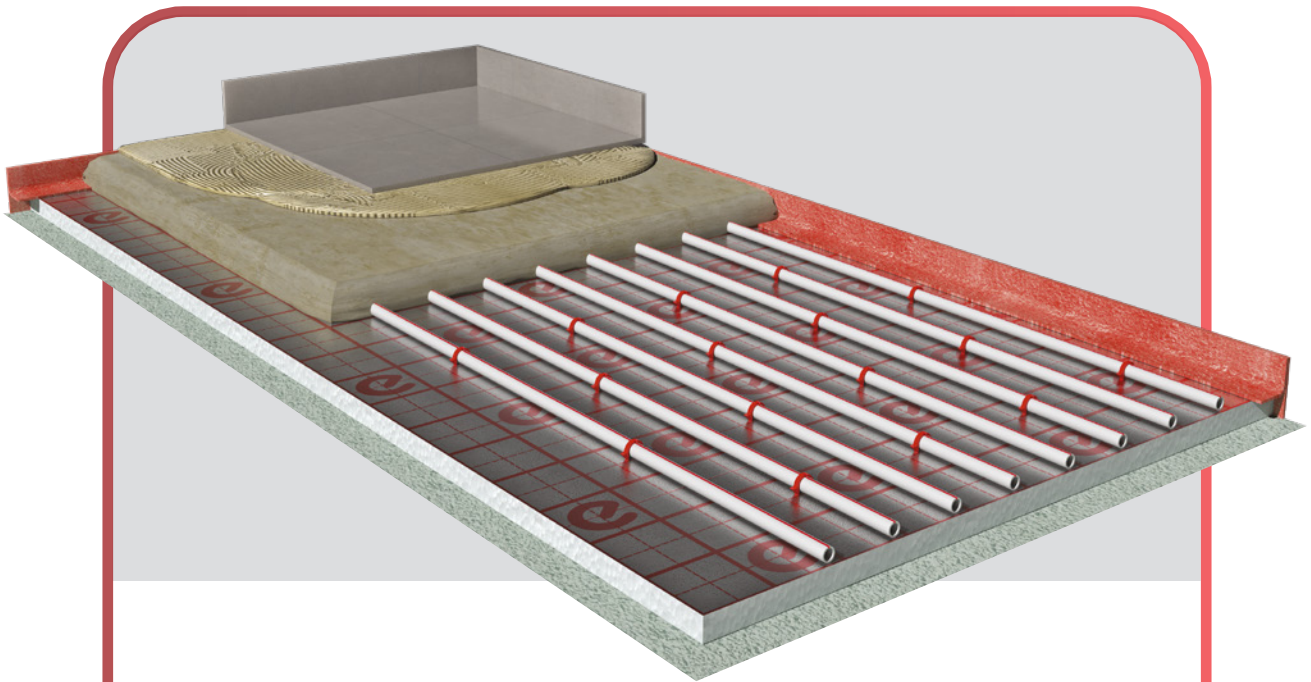

## Europlus-Flex

- Self-gluing flap for maximum board lamination speed.
- Increased tensile strength of the clip thanks to the aluminised sheet.
- Self-gluing flap for maximum board coupling speed.

Underfloor heating and cooling system comprising a flat expanded polystyrene insulation board with declared thermal conductivity  $\lambda_D$  of 0.034 W/mK (UNI EN 13163), and a pipe coupling system with special tacker clips.

The system has 3 different thicknesses that can be chosen based on the installation condition (minimum thermal resistance in accordance with UNI EN 1264). Depending on the heat requirement, pipe  $\varnothing$  16 to 17 mm and centre distances from 5 cm to 20 cm can be used.

The insulation board is protected at the top by an aluminised multilayer sheet (UNI EN 1264-4) on which guidelines for the laying of the pipe are marked at a distance of 50 mm; the upper sheet protrudes ~20 mm and is adhesive in the protruding part so as to cover the joints between the boards during laying. The system includes a double perimeter strip of closed-cell polyethylene foam of suitable height for the chosen insulation, which can be lifted and has a self-adhesive strip on the back; reaction to fire (EPS insulation): class E (EN13501-1).

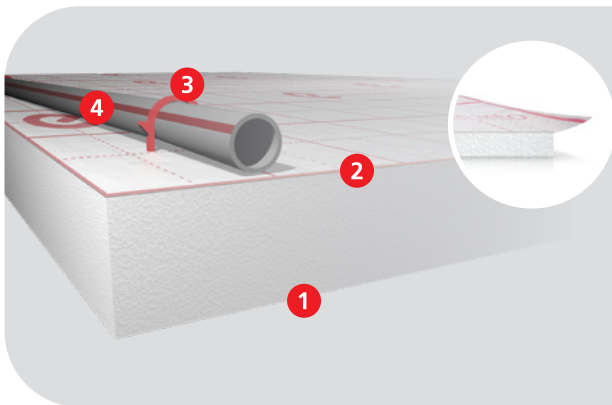

### System Composition

1. EPS insulation sheet.
2. Multilayer aluminised sheet.
3. Tension-resistant clip.
4. 5-layer MidiX Plus pipe.

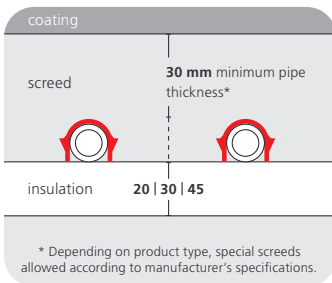

<b>Insulation</b>	EPS
$\lambda_D$	0.034 W/mK
<b>Thickness</b>	20   30   45 mm
<b>Pipe</b>	16 x 2   17 x 2 mm
<b>Pipe spacing</b>	5   7.5   10   15   20 cm

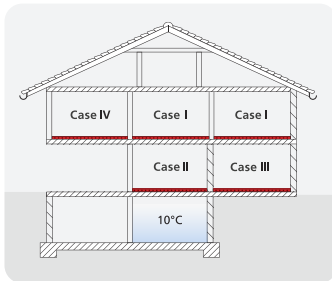

### Thicknesses in accordance with EN 1264:2021

Case I	30 mm
Case II and III	45 mm
Case IV [T external ≥ 0° C]	45 mm
Case IV [-5° C ≤ T external < 0° C]	
Case IV [-15° C ≤ T external < -5° C]	

### System yields in W/m<sup>2</sup>

Ambient temperature 20 °C, Δt = 5 K | Ambient temperature 26 °C, Δt = 2 K |  $R_{\lambda,B}$  [m<sup>2</sup> K/W] = thermal resistance of the coating.

System yields in winter															
T flow water [°C]		28		32		36		40		44		48			
pipe spacing [cm]		$R_{\lambda,B}$ [m <sup>2</sup> K/W]		10	15	10	15	10	15	10	15	10	15		
coating	ceramic	0.01		32	27	55	47	78	67	101	87	124	107	147	127
	wood 10 mm	0.06		25	22	42	38	60	54	78	69	96	85	114	101
	wood 16 mm	0.1 (standard)		21	19	36	32	51	46	66	60	81	73	96	87
	wood 20 mm	0.125		19	17	33	30	46	42	60	55	74	67	88	80

System yields in summer															
T flow water [°C]		14		15		16		17		18		19			
pipe spacing [cm]		$R_{\lambda,B}$ [m <sup>2</sup> K/W]		10	15	10	15	10	15	10	15	10	15		
coating	ceramic	0.01		-45	-41	-41	-37	-37	-33	-33	-30	-29	-26	-25	-22
	wood 10 mm	0.06		-37	-33	-33	-30	-30	-27	-27	-24	-23	-21	-20	-18
	wood 16 mm	0.1 (standard)		-34	-31	-31	-28	-28	-26	-25	-23	-22	-20	-19	-17
	wood 20 mm	0.125		-34	-31	-31	-28	-28	-25	-25	-23	-22	-20	-18	-17

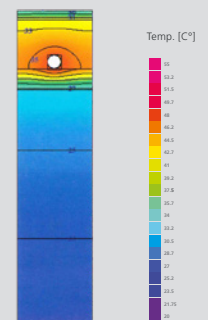

Yields determined by numerical simulations.

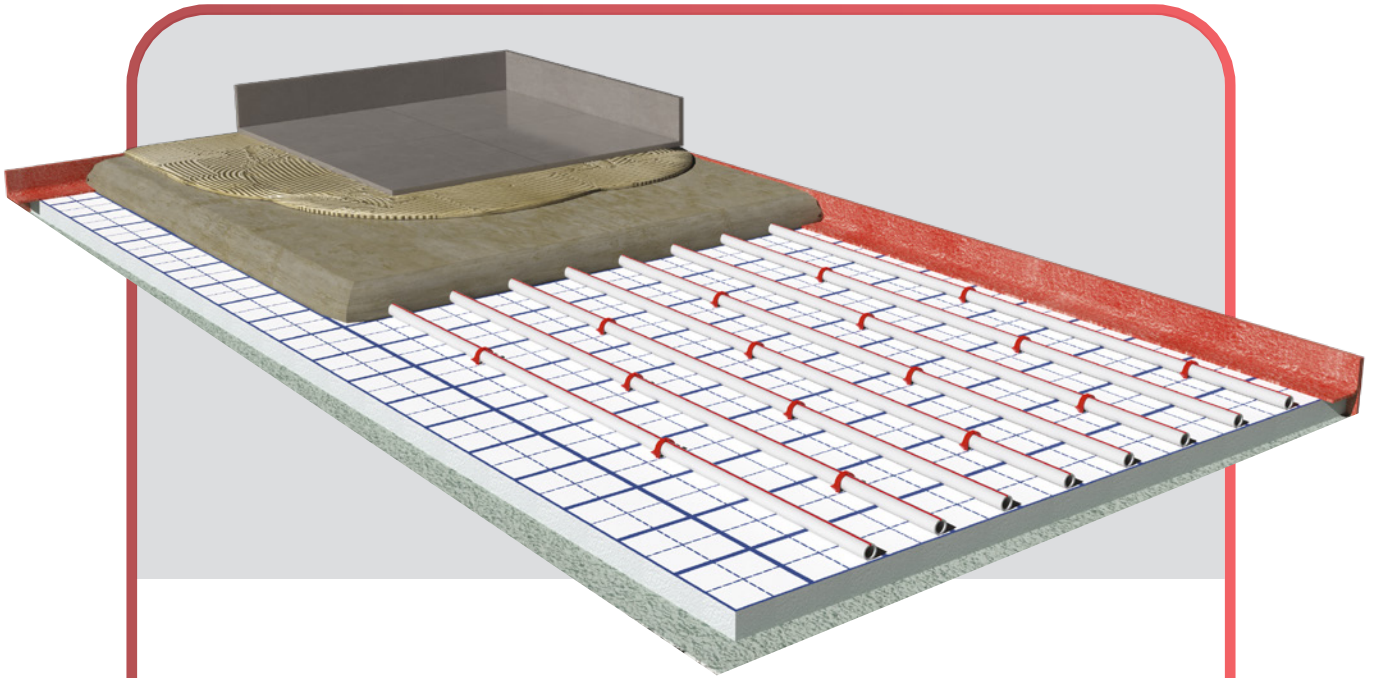

## Europlus-Acoustic

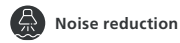

Noise reduction

- Sound pressure level attenuation of 26 or 28 dB.
- EPS insulation protected by multilayer sheeting.
- Sheetting provided with flap for coupling the boards during laying.

Underfloor heating and cooling system with a flat expanded polystyrene insulation board with declared thermal conductivity  $\lambda_D$  equal to 0.040 W/mK (UNI EN 13163), and a pipe coupling system with special tacker clips. Depending on the thermal requirements, it is possible to use pipework  $\varnothing 16 \div 17$  mm and centre distances from 5 cm to 20 cm.

The insulation board is protected on the top by a high-density polyethylene (HDPE) sheeting, with PE coating (UNI EN 1264-4) on which guidelines for the laying of the pipe are marked at a distance of 50 mm. Other characteristics: compressibility level CP2 (deformation of 2 mm under compression of 5.0 kPa); dynamic rigidity 20 MN/m<sup>3</sup>; sound pressure level attenuation to footsteps of 26 or 28 dB (DIN 4109- Bbl.1). The system includes a double perimeter strip in closed-cell polyethylene foam of suitable height, which can be lifted and has a self-adhesive band on the back; reaction to fire (EPS insulation): class E (EN13501-1).

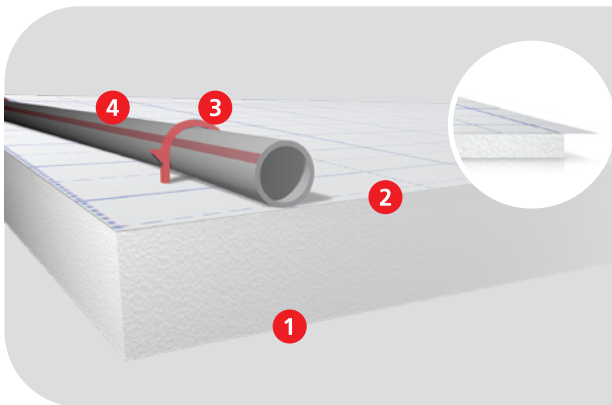

## System Composition

1. EPS insulation sheet.
2. Polyethylene sheet with PE coating.
3. Tension-resistant clip.
4. 5-layer MidiX Plus pipe.

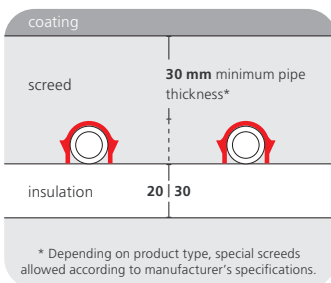

<b>Insulation</b>	EPS
$\lambda_D$	0.040 W/mK
<b>Thickness</b>	20   30 mm
<b>Acoustic</b>	20 mm $\Delta L_w = 26$ dB 30 mm $\Delta L_w = 28$ dB
<b>Pipe</b>	16 x 2   17 x 2   18 x 2   20 x 2 mm
<b>Pipe spacing</b>	5   7.5   10   15   20 cm

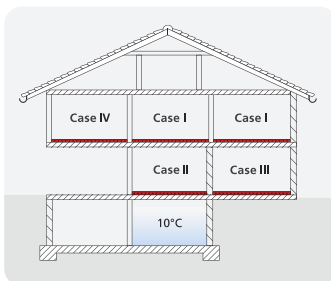

## Thicknesses in accordance with EN 1264:2021

Case I 30 mm

Case II and III

Case IV [T external  $\geq 0^\circ$  C]

Case IV [-5° C  $\leq$  T external < 0° C]

Case IV [-15° C  $\leq$  T external < -5° C]

## System yields in W/m<sup>2</sup>

Ambient temperature 20 °C,  $\Delta t = 5$  K | Ambient temperature 26 °C,  $\Delta t = 2$  K |  $R_{\lambda,B}$  [m<sup>2</sup> K/W] = thermal resistance of the coating.

System yields in winter																
T flow water [°C]				28		32		36		40		44		48		
pipe spacing [cm]		$R_{\lambda,B}$ [m <sup>2</sup> K/W]	10	15	10	15	10	15	10	15	10	15	10	15	10	15
coating	ceramic	0.01	32	27	55	47	78	67	101	87	124	107	147	127		
	wood 10 mm	0.06	25	22	42	38	60	54	78	69	96	85	114	101		
	wood 16 mm	0.1 (standard)	21	19	36	32	51	46	66	60	81	73	96	87		
	wood 20 mm	0.125	19	17	33	30	46	42	60	55	74	67	88	80		

System yields in summer																
T flow water [°C]				14		15		16		17		18		19		
pipe spacing [cm]		$R_{\lambda,B}$ [m <sup>2</sup> K/W]	10	15	10	15	10	15	10	15	10	15	10	15	10	15
coating	ceramic	0.01	-45	-41	-41	-37	-37	-33	-33	-30	-29	-26	-25	-22		
	wood 10 mm	0.06	-37	-33	-33	-30	-30	-27	-27	-24	-23	-21	-20	-18		
	wood 16 mm	0.1 (standard)	-34	-31	-31	-28	-28	-26	-25	-23	-22	-20	-19	-17		
	wood 20 mm	0.125	-34	-31	-31	-28	-28	-25	-25	-23	-22	-20	-18	-17		

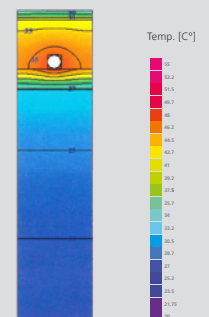

Yields determined by numerical simulations.

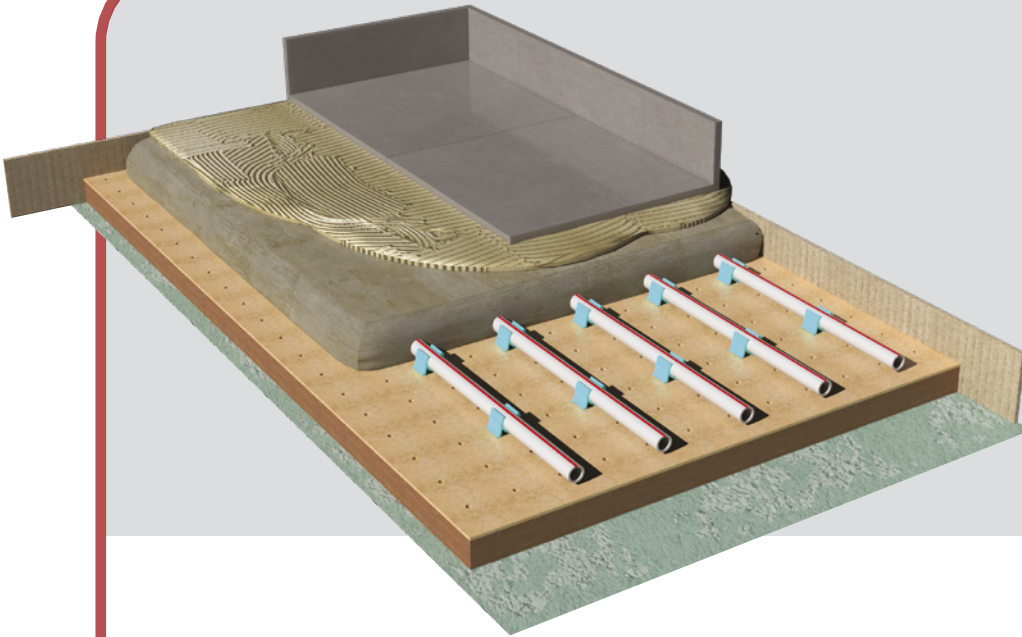

## Ecoplus

Insulation  
100% environmentally  
friendly

- 100% natural wood fibre insulation.
- Patented clip fastening system for maximum pipe tightness.
- Board with low dynamic rigidity (class CP2) that can be used with floor loads exceeding 500 kg/m<sup>3</sup>.

Underfloor heating and cooling system comprising a wood fibre insulation board with declared thermal conductivity  $\lambda_D$  equal to 0.038 W/mK (UNI EN 13171 and UNI EN 12667), with compressibility CP2 (UNI EN 12431), protected at the top and bottom by polyethylene-coated paper with SD value equal to 6 m; in the upper part of the package a high-density wood fibre sheet is provided to allow the clips for anchoring the pipe.

The system includes 2 different thicknesses that can be chosen based on the installation condition and is supplied together with a compressed natural cork insulation board available in 3 different thicknesses. The system provides a dynamic stiffness of 28 MN/m<sup>3</sup> (for the 22.4 mm thickness) and 40 MN/m<sup>3</sup> (for the 32.4 mm thickness).

It is possible to use  $\varnothing$  18 mm tubing and spacings of 10 to 20 cm. The system includes a perimeter strip and expansion joints made of corrugated and waxed cardboard, Ecoplus-type polyamide board fasteners necessary for joining the perforated wood-fibre boards, a polyethylene foam insulation sheet to protect the pipe, and a 0.2 mm thick polyethylene sheet to be provided under the board. In the case of a self-levelling screed, a 0.1 mm thick polyethylene sheet can be provided.



### System Composition

1. 100% natural wood fibre insulation.
2. Wooden board with clip fastening system.
3. Polyethylene paper.
4. Tension-resistant clip.
5. 5-layer MidiX Plus pipe.

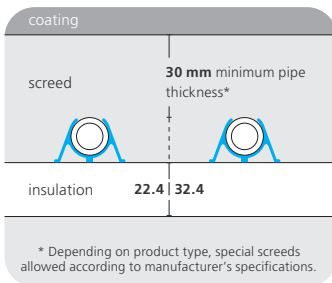

<b>Insulation</b>	Wood fibre
$\lambda_D$	0.038 W/mK
<b>Thickness</b>	22.4   32.4 mm
<b>Pipe</b>	18 x 2 mm
<b>Pipe spacing</b>	10   15   20 cm

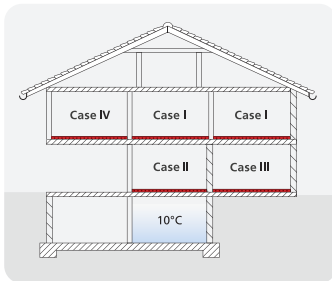

### Thicknesses in accordance with EN 1264:2021

Case I	32.4 mm   22.4 + 20* mm
Case II and III	32.4 + 20* mm
Case IV [T external ≥ 0° C]	32.4 + 20* mm
Case IV [-5° C ≤ T external < 0° C]	22.4 + 40* mm
Case IV [-15° C ≤ T external < -5° C]	22.4 + 40* + 20* mm

\* cork sheet

### System yields in W/m<sup>2</sup>

Ambient temperature 20 °C, Δt = 5 K | Ambient temperature 26 °C, Δt = 2 K |  $R_{\lambda,B}$  [m<sup>2</sup> K/W] = thermal resistance of the coating.

System yields in winter															
T flow water [°C]				28		32		36		40		44		48	
pipe spacing [cm]		$R_{\lambda,B}$ [m <sup>2</sup> K/W]		10	15	10	15	10	15	10	15	10	15	10	15
coating	ceramic	0.01		32	27	55	47	78	67	101	87	124	107	147	127
	wood 10 mm	0.06		25	22	42	38	60	54	78	69	96	85	114	101
	wood 16 mm	0.1 (standard)		21	19	36	32	51	46	66	60	81	73	96	87
	wood 20 mm	0.125		19	17	33	30	46	42	60	55	74	67	88	80

System yields in summer															
T flow water [°C]				14		15		16		17		18		19	
pipe spacing [cm]		$R_{\lambda,B}$ [m <sup>2</sup> K/W]		10	15	10	15	10	15	10	15	10	15	10	15
coating	ceramic	0.01		-45	-41	-41	-37	-37	-33	-33	-30	-29	-26	-25	-22
	wood 10 mm	0.06		-37	-33	-33	-30	-30	-27	-27	-24	-23	-21	-20	-18
	wood 16 mm	0.1 (standard)		-34	-31	-31	-28	-28	-26	-25	-23	-22	-20	-19	-17
	wood 20 mm	0.125		-34	-31	-31	-28	-28	-25	-25	-23	-22	-20	-18	-17

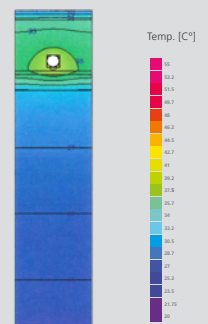

Yields determined by numerical simulations.

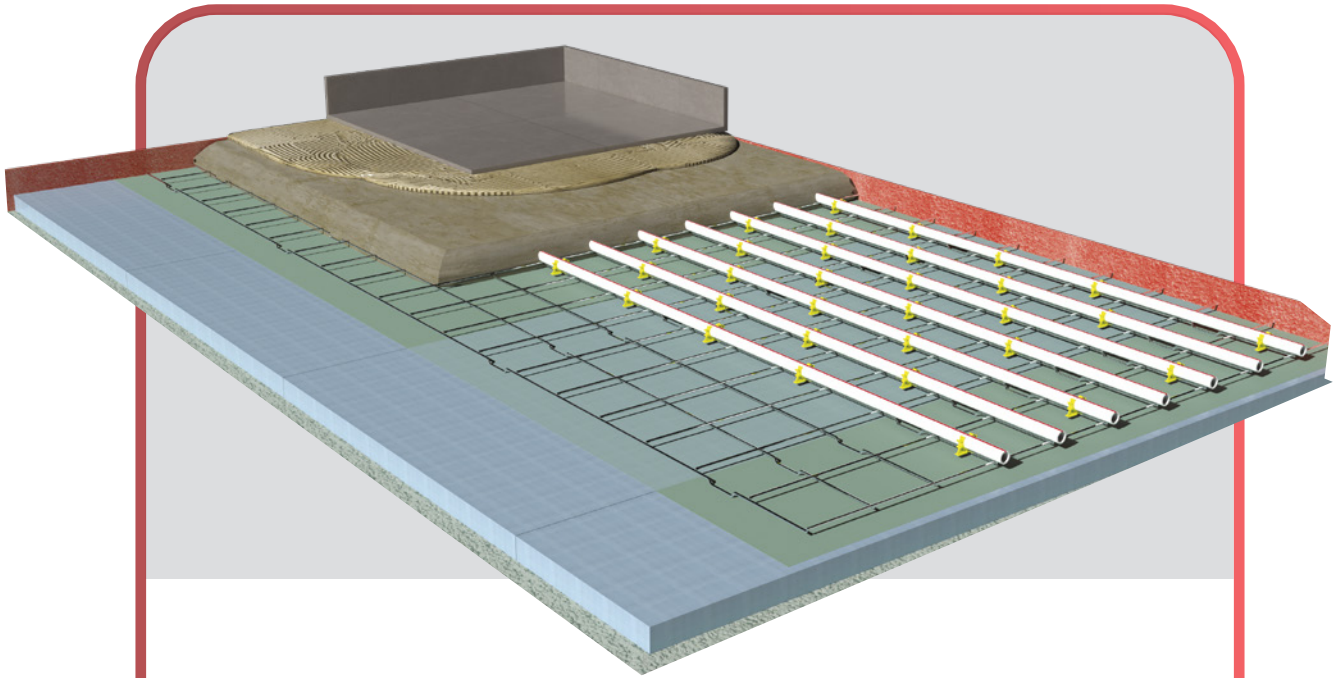

## Eurogrid

- Excellent versatility of application: from residential to tertiary.
- Choice of insulation type (EPS or XPS) as appropriate.
- The MidiX Plus piping embedded in the screed maximises heat exchange.

Underfloor system ideal for heating large areas, warehouses and large sheds. The Eurogrid system includes a 17 mm  $\varnothing$  pipe coupling system by means of clips inserted on the support mesh, laid with different spacing between the pipes for adapting the capacity to individual needs. The system consists of a flat expanded or extruded polystyrene insulation board and 3 mm steel wire electro-welded mesh, also in the version with a 6 mm high foot, to be laid on top of the insulation board to provide support for the attachment of the Eurogrid pipe clips. The system is completed with the elements necessary for correct installation such as expansion joints, polyethylene foam insulation sheeting to protect the pipe, a 0.2 mm thick polyethylene sheet to be provided under the board, and screed shrinkage-proof mesh.



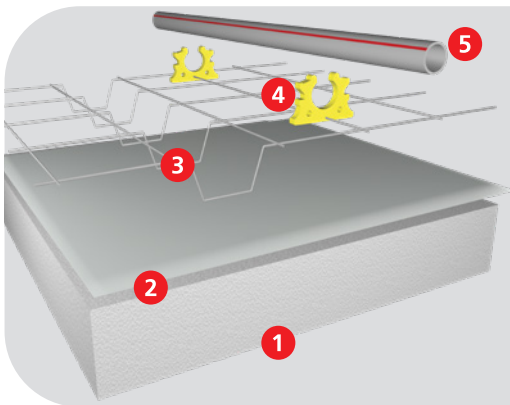

### System Composition

1. EPS or XPS insulation.
2. PE foil.
3. Electro-welded steel wire mesh.
4. Clip with net attachment.
5. 5-layer MidiX Soft pipe.

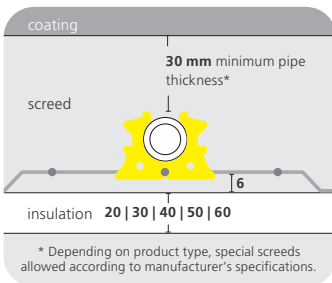

<b>Insulation</b>	EPS
	XPS <small>certificato</small> <b>CAM</b>
$\lambda_D$	0.033 W/mK
<b>Thickness</b>	EPS: 200 kPa 20   30   40 mm
	XPS: 250 kPa 20 mm
	300 kPa 30   40   50   60 mm
	500 kPa 50   60 mm
<b>Pipe</b>	17 x 2 mm

### System yields in W/m<sup>2</sup>

Ambient temperature 20 °C,  $\Delta t = 5$  K | Ambient temperature 26 °C,  $\Delta t = 2$  K |  $R_{\lambda,B}$  [m<sup>2</sup> K/W] = thermal resistance of the coating.

		System yields in winter											
T flow water [°C]		28		32		36		40		44		48	
pipe spacing [cm]	$R_{\lambda,B}$ [m <sup>2</sup> K/W]	10	20	10	20	10	20	10z	20	10	20	10	20
no coating	0	23	18	39	32	55	45	72	59	88	72	104	85

		System yields in summer											
T flow water [°C]		14		15		16		17		18		19	
pipe spacing [cm]	$R_{\lambda,B}$ [m <sup>2</sup> K/W]	10	20	10	20	10	20	10	20	10	20	10	20
no coating	0	-40	-34	-36	-31	-33	-28	-29	-25	-25	-22	-22	-19

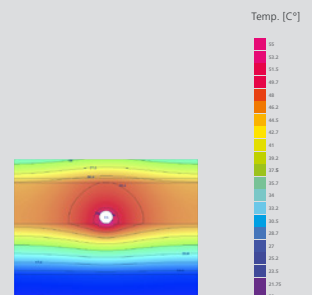

Yields determined by numerical simulations.

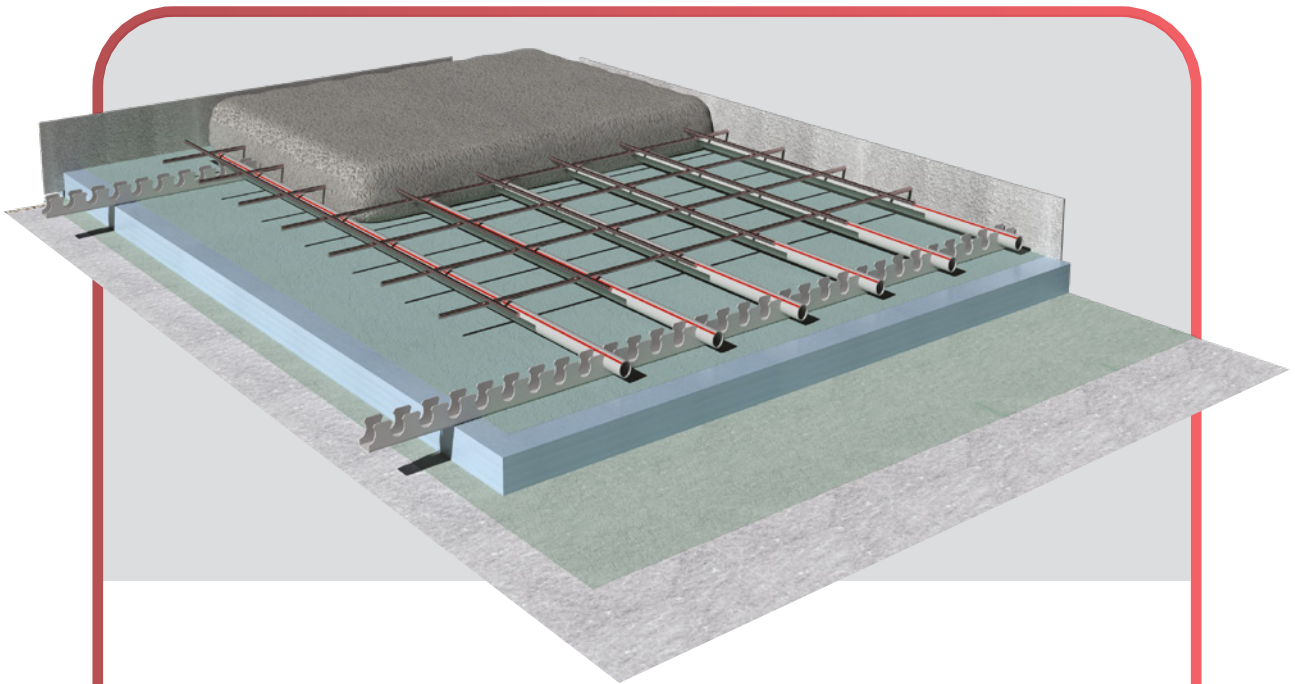

## Eurobarra

- Ideal for warehouses and halls with great heights.

Underfloor system ideal for heating warehouses and halls with great heights. The pipe-work must be laid in serpentine form with the aid of U-profiles. If insulation is present, it is recommended to use Euroflex clips to fix the bar to the insulation, especially near the coil heads. Extruded polystyrene insulation of the required thickness can be provided under the screed. The system is completed with the necessary elements for correct installation such as: expansion joints, insulation sheeting in expanded polyethylene to protect the pipe, a 0.2 mm thick polyethylene sheet to be provided under the board.

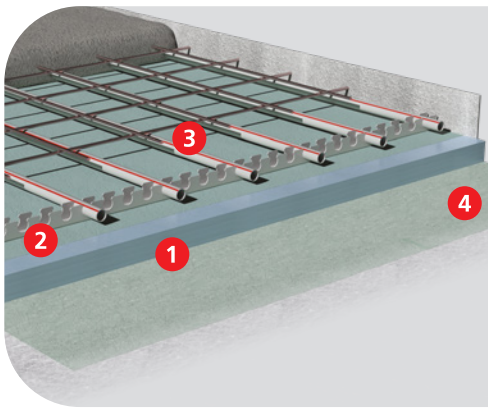

## System Composition

1. XPS insulation.
2. U-shaped pipe stop profile.
3. 5-layer MidiX Plus pipe.
4. PE foil.

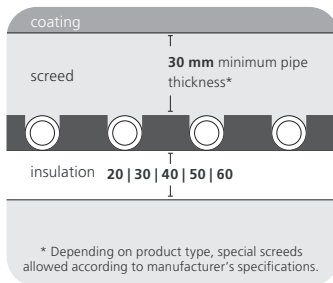

<b>Insulation</b>	XPS <small>certificato</small> CAM
$\lambda_D$	0.033 W/mK
<b>Thickness</b>	250 kPa 20 mm 300 kPa 30   40   50   60 mm 500 kPa 50   60 mm
<b>Pipe</b>	20 x 2   25 x 2.3 mm

## System yields in W/m<sup>2</sup>

Ambient temperature 20 °C,  $\Delta t = 5$  K | Ambient temperature 26 °C,  $\Delta t = 2$  K |  $R_{\lambda,B}$  [m<sup>2</sup> K/W] = thermal resistance of the coating.

		System yields in winter											
T flow water [°C]		28		32		36		40		44		48	
pipe spacing [cm]	$R_{\lambda,B}$ [m <sup>2</sup> K/W]	20	25	20	25	20	25	20	25	20	25	20	25
no coating	0	29	25	44	39	59	53	74	66	89	80	104	93

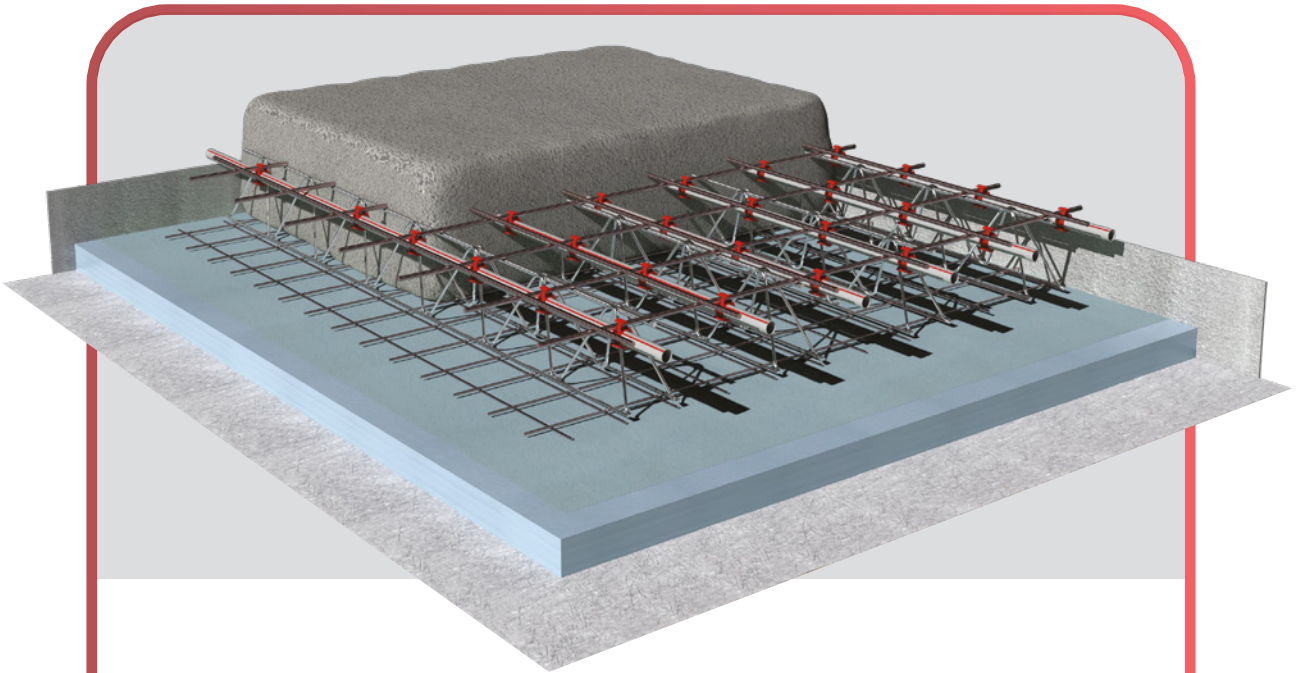

## Euroindustry

- Ideal for warehouses and halls with great heights in which the structural engineer planned to reinforce the screed due to high loads and/or sagging ground.
- Highly efficient system thanks to a special clip that allows the pipe to be applied in a raised position within the reinforced screed.

Underfloor system ideal for heating warehouses and halls with great heights.

The Euroindustry system involves lifting the plant pipe and hooking it with special clips to an electro-welded mesh resting on the trusses on the alternative system indicated by the structural engineer for the load requirements or the geological conditions of the ground on which the shed is to be built. A necessary and sufficient condition for the applicability of the Euroindustry system on the reinforcement specified by the structural engineer is that the upper mesh has 8 mm wire. The pipe must be laid in a serpentine fashion using the U-shaped pro-wires in the free spaces between the vertical elements (e.g. trusses) of the reinforcement planned by the structural engineer.

Extruded polystyrene insulation of the required thickness can be provided under the screed. The system is completed with the necessary elements for correct installation such as: expansion joints, expanded polyethylene insulation sheeting to protect the pipe, a 0.2 mm thick polyethylene sheet to be provided under the board.

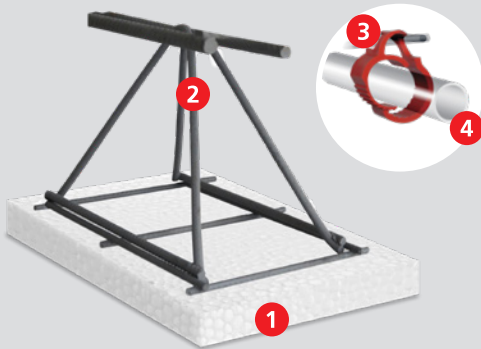

### System Composition

1. XPS insulation.
2. Metal structure.
3. Patented clip with attachment to structure.
4. 5-layer MidiX Plus pipe.

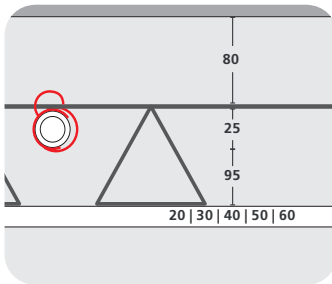

<b>Insulation</b>	XPS <small>certificato</small> CAM
$\lambda_D$	0.033 W/mK
<b>Thickness</b>	250 kPa 20 mm 300 kPa 30   40   50   60 mm 500 kPa 50   60 mm
<b>Pipe</b>	20 x 2   25 x 2.3 mm

### System yields in W/m<sup>2</sup>

Ambient temperature 20 °C,  $\Delta t = 5$  K | Ambient temperature 26 °C,  $\Delta t = 2$  K |  $R_{\lambda,B}$  [m<sup>2</sup>K/W] = thermal resistance of the coating.

		System yields in winter											
T flow water [ °C ]		28		32		36		40		44		48	
pipe spacing [cm]	$R_{\lambda,B}$ [m <sup>2</sup> K/W]	20	25	20	25	20	25	20	25	20	25	20	25
no coating	0	36	32	53	48	71	64	89	79	107	95	125	111

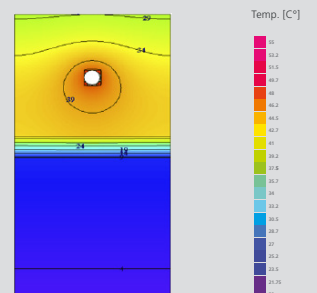

Yields determined by numerical simulations.

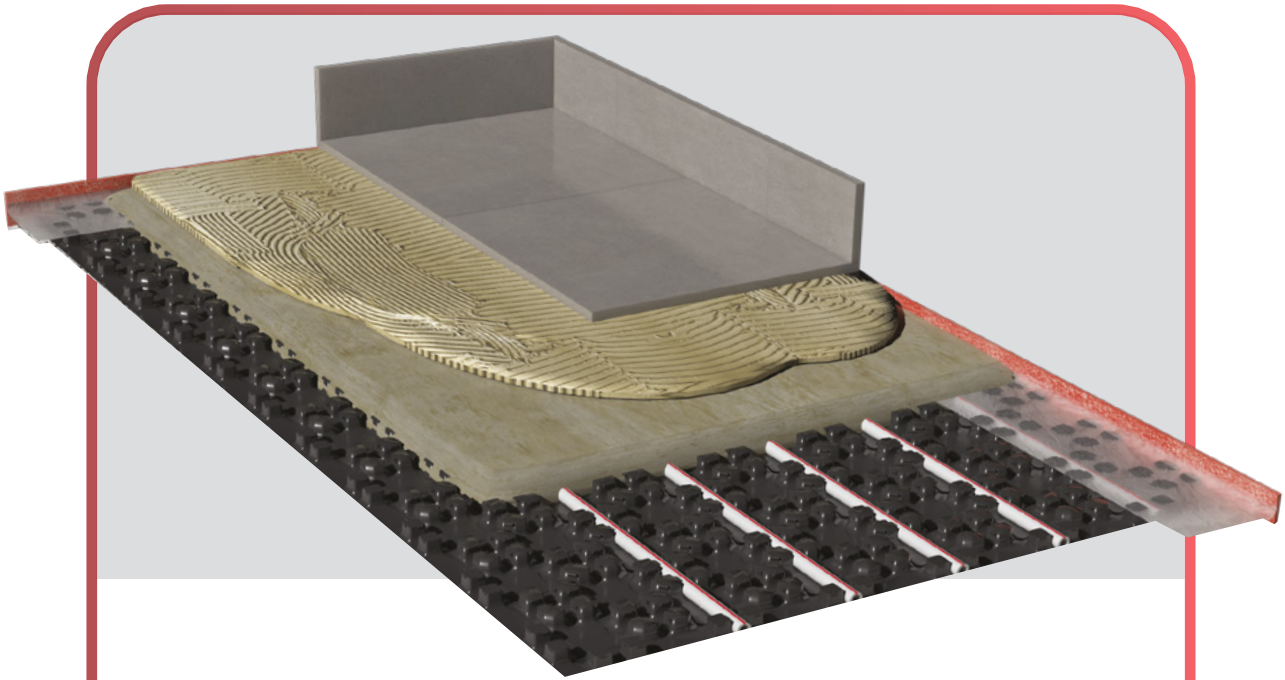

## Euroflex TFS mini



- Sheet with a height of 14 mm.
- Certified with Knauf's NE425 self-levelling screed and NE499 super-levelling screed.
- Thermoformed PS sheet resistant to laying on site.
- MidiX Plus 12 x 2 mm pipe can also be laid at 45°.
- Self-adhesive base coat with maximum bonding to the screed.
- System standardised by UNI EN 1264:2021 (type J).

Underfloor heating and cooling system with thermoformed PS sheeting. The sheet is only 14 mm high, measures 1125 x 625 mm (sheeting surface 1150 x 650 mm) and, depending on the heat requirement, allows the use of a 12 mm external diameter pipe and multiple 50 mm centre distances that can be laid at 90° and 45°. The embossing is designed to maximise the contact area of the pipe with the screed, increase the performance of the system and allow it to be attached without the use of clips.

In addition, the specific geometry of the embossing together with the high thickness of the thermoformed sheeting of 1 mm provide high mechanical resistance to footfall. The sheets have joints on the perimeter area to join them by partial overlapping and prevent them from shifting after laying. The system includes a perimeter strip of closed-cell polyethylene foam with a polyethylene sheet of a suitable height for the chosen sheet, which can be lifted and has a self-adhesive band on the back at full height.

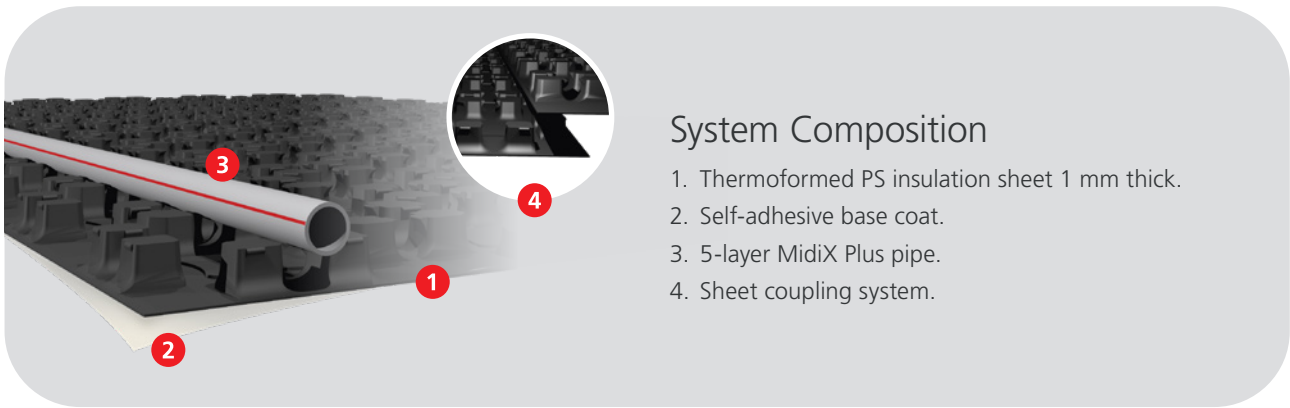

### System Composition

1. Thermoformed PS insulation sheet 1 mm thick.
2. Self-adhesive base coat.
3. 5-layer MidiX Plus pipe.
4. Sheet coupling system.

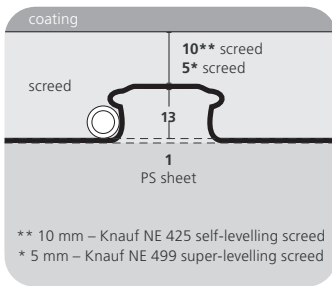

<b>Insulation</b>	Sheet (1 mm)
<b>Thickness</b>	14 mm
<b>Pipe</b>	12 x 2 mm
<b>Pipe spacing</b>	5   10   15   20 cm

#### Radiant system height – 24 mm\*

Compatible with KNAUF NE 425 self-levelling screed

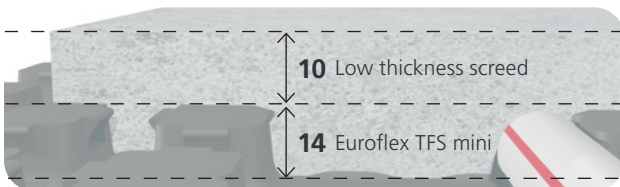

\* thickness of coating excluded

#### Radiant system height – 19 mm\*

Compatible with KNAUF NE 499 super-levelling screed

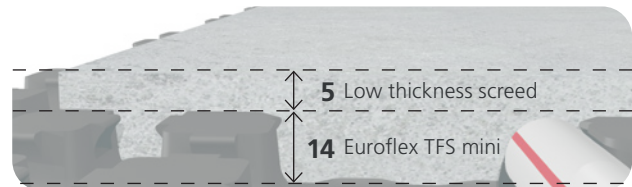

\* thickness of coating excluded

#### System yields in W/m<sup>2</sup> – Euroflex TFS mini with 12 x 2 mm pipe and 10 mm screed in a heated room

Ambient temperature 20 °C, Δt = 5 K | Ambient temperature 26 °C, Δt = 2 K | R<sub>λ,B</sub> [m<sup>2</sup> K/W] = thermal resistance of the coating.

System yields in winter														
T flow water [°C]		28		32		36		40		44		48		
pipes pacing [cm]	R <sub>λ,B</sub> [m <sup>2</sup> K/W]	10	15	10	15	10	15	10	15	10	15	10	15	
coating	ceramic	0.01	31	25	57	45	82	65	107	85	132	104	156	124
	wood 10 mm	0.06	23	19	42	34	60	49	79	64	97	78	115	93
	wood 16 mm	0.1 (standard)	19	16	35	29	51	42	66	55	82	68	97	80
	wood 20 mm	0.125	18	15	32	27	46	38	60	50	74	62	88	73

System yields in summer														
T flow water [°C]		14		15		16		17		18		19		
pipes pacing [cm]	R <sub>λ,B</sub> [m <sup>2</sup> K/W]	10	15	10	15	10	15	10	15	10	15	10	15	
coating	ceramic	0.01	-47	-39	-43	-36	-39	-32	-34	-28	-30	-25	-26	-21
	wood 10 mm	0.06	-38	-31	-34	-28	-31	-26	-27	-23	-24	-20	-20	-17
	wood 16 mm	0.1 (standard)	-33	-28	-30	-25	-27	-23	-24	-20	-21	-18	-18	-15
	wood 20 mm	0.125	-31	-26	-28	-23	-25	-21	-22	-19	-19	-16	-16	-14

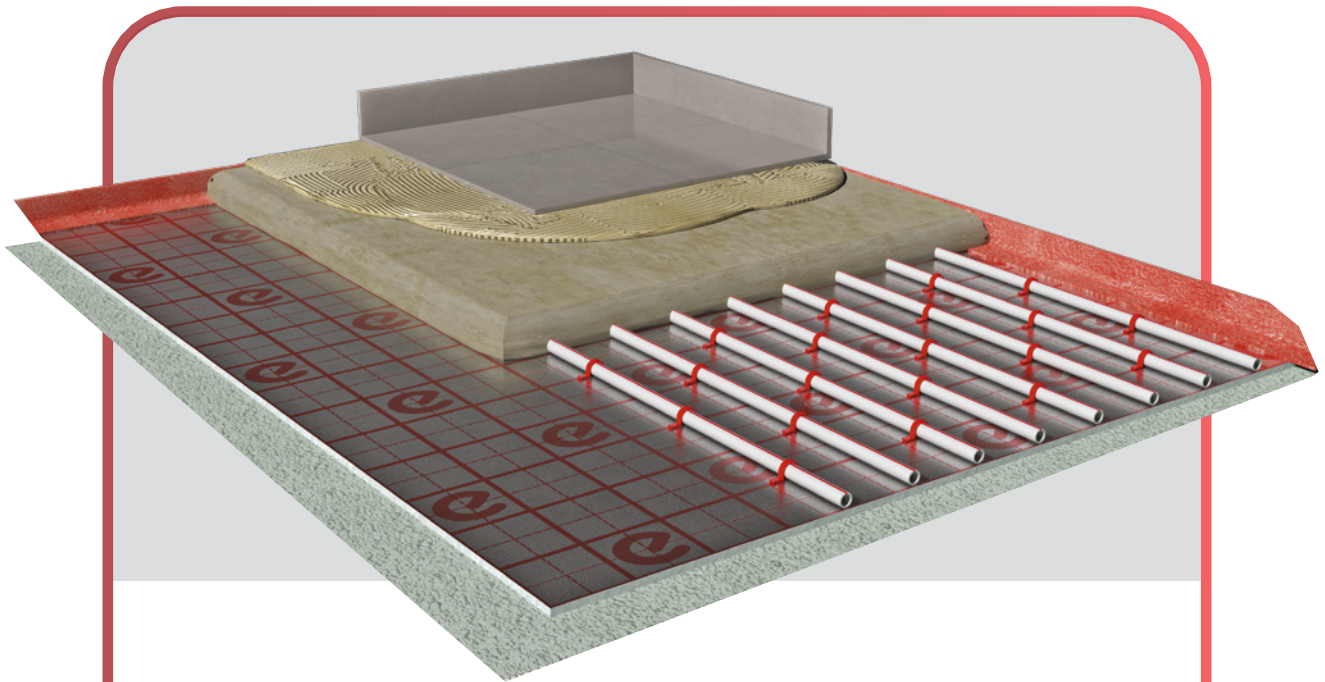

## Europlus-Ten



- Patented clip anchoring system in only 10 mm EPS.
- Certified with Knauф's NE425 self-levelling screed.
- Self-gluing flap for maximum board coupling speed.
- Increased tensile strength of the clip thanks to the aluminised sheet.
- Self-adhesive base coat with maximum adhesion to the substrate.

An underfloor heating and cooling system with a flat insulation board made of expanded polystyrene and a pipe attachment system with special patented polyamide tacker clips for the system. The board thickness is 10 mm and is therefore specific for cases where the need is to reduce thickness. Depending on the heat requirement, it is possible to use pipework  $\varnothing 12 \div 17$  and centre distances from 5 cm to 20 cm.

The board has adhesive film on the underside covered with a sheet of paper so that it can be glued to the floor or other suitable insulation materials, thus facilitating installation. The insulation board is made of expanded polystyrene covered with an aluminised multilayer sheet, with guide lines at a distance of 50 mm useful for laying the pipe with the correct pipe spacing. The system includes a double perimeter strip in closed-cell polyethylene foam 80 mm high, which can be lifted and has a self-adhesive strip on the back; reaction to fire (insulation EPS) Class E (EN 13501-1).



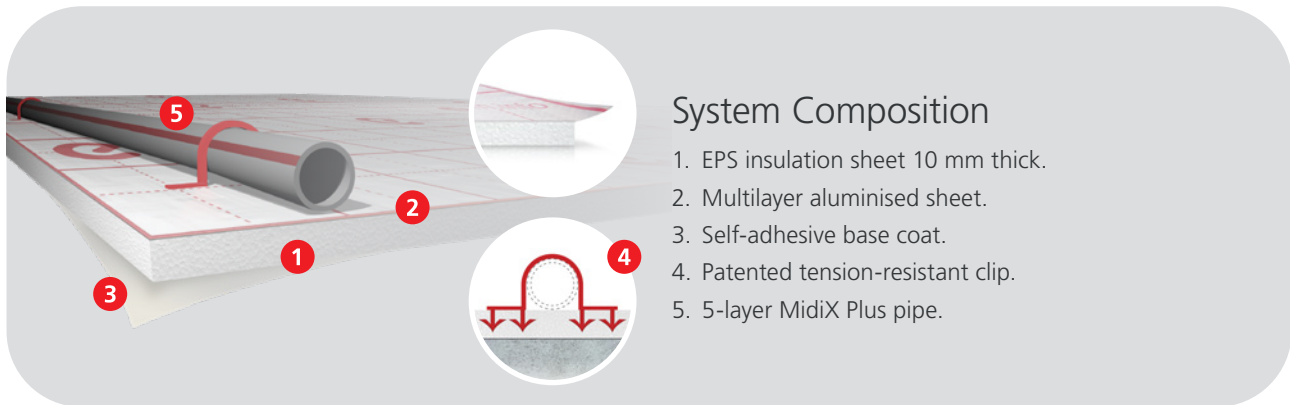

## System Composition

1. EPS insulation sheet 10 mm thick.
2. Multilayer aluminised sheet.
3. Self-adhesive base coat.
4. Patented tension-resistant clip.
5. 5-layer MidiX Plus pipe.

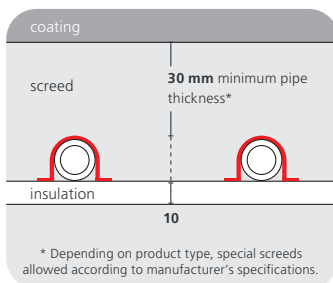

<b>Insulation</b>	EPS
$\lambda_D$	0.034 W/mK
<b>Thickness</b>	10 mm
<b>Pipe</b>	12 x 2   14 x 2   16 x 2   17 x 2 mm
<b>Pipe spacing</b>	5   7.5   10   15   20 cm

## System yields in W/m<sup>2</sup>

Ambient temperature 20 °C,  $\Delta t = 5$  K | Ambient temperature 26 °C,  $\Delta t = 2$  K |  $R_{\lambda,B}$  [m<sup>2</sup> K/W] = thermal resistance of the coating.

System yields in winter														
T flow water [°C]		28		32		36		40		44		48		
pipe spacing [cm]	$R_{\lambda,B}$ [m <sup>2</sup> K/W]	10	15	10	15	10	15	10	15	10	15	10	15	
coating	ceramic	0.01	32	27	55	47	78	67	101	87	124	107	147	127
	wood 10 mm	0.06	25	22	42	38	60	54	78	69	96	85	114	101
	wood 16 mm	0.1 (standard)	21	19	36	32	51	46	66	60	81	73	96	87
	wood 20 mm	0.125	19	17	33	30	46	42	60	55	74	67	88	80

System yields in summer														
T flow water [°C]		14		15		16		17		18		19		
pipe spacing [cm]	$R_{\lambda,B}$ [m <sup>2</sup> K/W]	10	15	10	15	10	15	10	15	10	15	10	15	
coating	ceramic	0.01	-45	-41	-41	-37	-37	-33	-33	-30	-29	-26	-25	-22
	wood 10 mm	0.06	-37	-33	-33	-30	-30	-27	-27	-24	-23	-21	-20	-18
	wood 16 mm	0.1 (standard)	-34	-31	-31	-28	-28	-26	-25	-23	-22	-20	-19	-17
	wood 20 mm	0.125	-34	-31	-31	-28	-28	-25	-25	-23	-22	-20	-18	-17

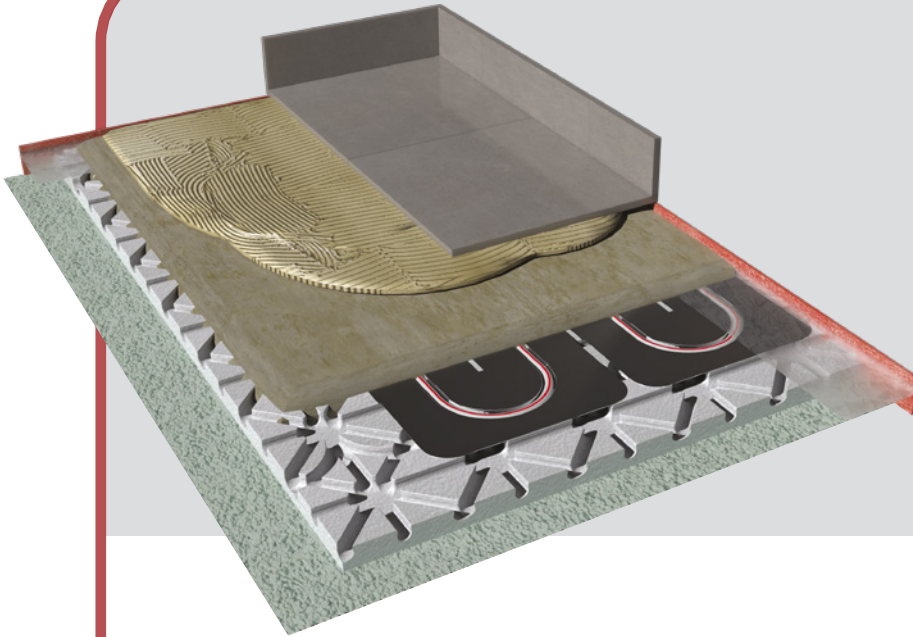

## Euroslim

- Low-thickness system on which drywall boards (not included) can be applied to support the floor covering.
- Galvanised steel diffusers that promote heat exchange between the pipe and the surface.
- Special interlocking to eliminate thermal bridges.
- Due to its low weight on the floor, it is ideal for renovations (plaster-fibre 18 mm, weight 32 kg/m<sup>2</sup>).

Low-thickness underfloor heating and cooling system with an expanded polystyrene insulation board shaped so that the pipework can be inserted into the special grooves above which special steel diffusers have been inserted; when hot water flows, the heat from the pipework spreads over the surface via the diffuser and transmits the heat flow to the screed or steel sheet laid above. The piping is laid with different spacing between the pipes in order to adapt to the heat requirements in each case.

The moulded insulation board allows excellent system efficiencies even with reduced thicknesses, while the high compressive strength (200 kPa at 10% deflection) ensures a high load bearing capacity of the board. The board can be finished with a dry screed, self-levelling screed or double steel sheet.

The system is compatible with all floor coverings (with a maximum thermal resistance of 0.15 m<sup>2</sup> K/W as per UNI EN 1264) subject to verification with the floor manufacturer (glue, formats, etc.).

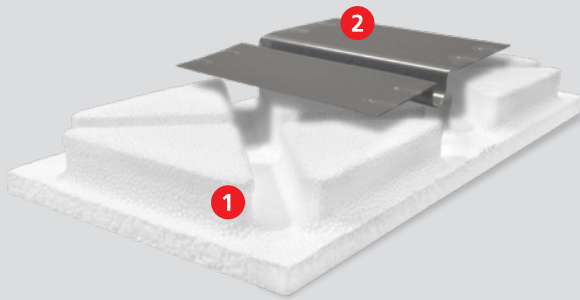

### System Composition

1. EPS insulation sheet.
2. Galvanised steel heat diffuser.

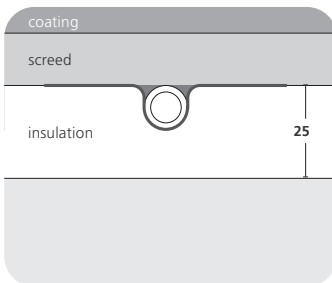

<b>Insulation</b>	EPS
$\lambda_D$	0.033 W/mK
<b>Thickness</b>	25 mm
<b>Pipe</b>	14 x 2 mm
<b>Pipe spacing</b>	12.5   25 cm

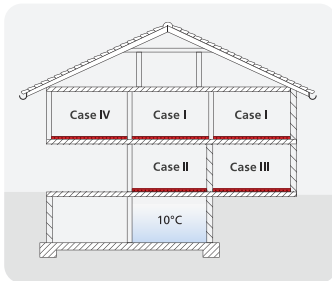

### Thicknesses in accordance with EN 1264:2021

Case I	25 + 20* mm
Case II and III	25 + 30* mm
Case IV [T external ≥ 0° C]	25 + 30* mm
Case IV [-5° C ≤ T external < 0° C]	25 + 40* mm
Case IV [-15° C ≤ T external < -5° C]	25 + 50* mm

\* additional EPS sheet

### System yields in W/m<sup>2</sup>

Ambient temperature 20 °C, Δt = 5 K | Ambient temperature 26 °C, Δt = 2 K |  $R_{\lambda,B}$  [m<sup>2</sup> K/W] = thermal resistance of the coating.

System yields in winter														
T flow water [°C]		28		32		36		40		44		48		
pipe spacing [cm]		$R_{\lambda,B}$ [m <sup>2</sup> K/W]	12.5	25	12.5	25	12.5	25	12.5	25	12.5	25	12.5	25
coating	ceramic	0.01	32	21	56	37	79	52	103	67	126	83	150	98
	wood 10 mm	0.06	24	17	42	30	60	42	77	55	95	68	113	80
	wood 16 mm	0.1 (standard)	20	15	34	26	49	37	63	48	78	59	92	70
	wood 20 mm	0.125	18	14	31	24	44	34	57	44	70	54	84	64

System yields in summer														
T flow water [°C]		14		15		16		17		18		19		
pipe spacing [cm]		$R_{\lambda,B}$ [m <sup>2</sup> K/W]	12.5	25	12.5	25	12.5	25	12.5	25	12.5	25	12.5	25
coating	ceramic	0.01	-45	-32	-41	-29	-37	-26	-33	-23	-28	-21	-24	-18
	wood 10 mm	0.06	-35	-27	-32	-24	-29	-22	-26	-20	-23	-17	-19	-15
	wood 16 mm	0.1 (standard)	-33	-25	-30	-23	-27	-21	-24	-18	-21	-16	-18	-14
	wood 20 mm	0.125	-33	-25	-30	-23	-27	-21	-24	-18	-21	-16	-18	-14

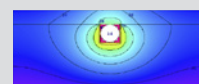

Yields determined by numerical simulations.



More quality for the indoor **climate**.  
 More value for **well-being**.

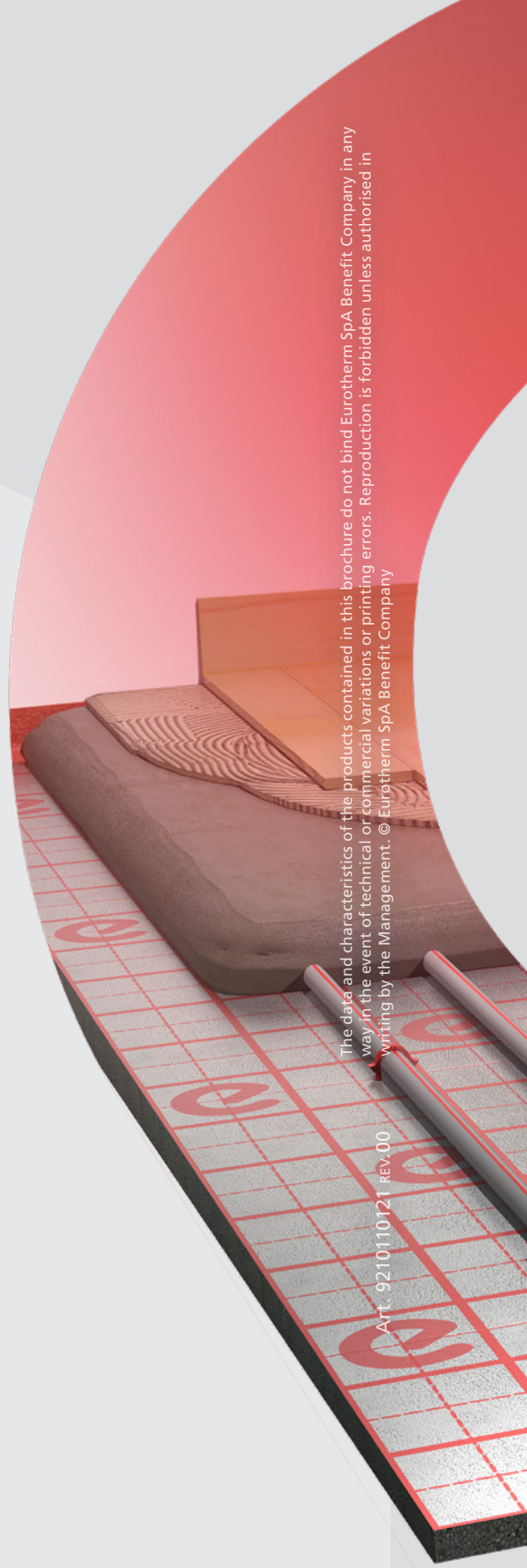

The data and characteristics of the products contained in this brochure do not bind Eurotherm SpA Benefit Company in any way in the event of technical or commercial variations or printing errors. Reproduction is forbidden unless authorised in writing by the Management. © Eurotherm SpA Benefit Company

Att. 9210110121 REV.00

**eurotherm**<sup>®</sup> | Certified  
 radiant comfort systems | Corporation

Eurotherm SpA Benefit Company  
 Pillhof 91 – 39057 Bolzano – Italy  
 T +39 0471 63 55 00  
 mail@eurotherm.info



**ESNA-SOA**

eurotherm.info |

