



Smart 365 regulation

Eurotherm control systems are high-tech solutions for the fully remote management of space heating and cooling.



The intelligence of SmartComfort 365 controlling the radiant system

A performance car needs an exceptional driver. This is why Eurotherm radiant systems are driven by management technology that is as advanced as it is simple to use. **SmartComfort 365** and **SmartOne 365** are high-tech solutions for fully remote management of heating and cooling through PID (Proportional Integral Derivative Strategy) control logic adapted for radiant systems. Both control underfloor, wall and ceiling radiant systems through software that memorises usage habits and optimises switching on, dimming and switching off to keep costs down without sacrificing comfort. The performance of the system is always top notch.



How the Smart 365 system works

As in a perfect team game, the SmartComfort 365 display communicates with the SmartBase, a latest-generation electronic brain, which in turn receives impulses and selective information from the SmartPoints, bus-connected thermostats/humidistats located in each room. Perfectly integrated with Deuclima-VMC, in cooling mode the humidity threshold is controlled and air exchange is guaranteed.

Advanced air treatment management

Depending on the characteristics of the system, advanced functions are available such as air flow selection in fresh air mode, variation air flow rate according to dehumidification and room integration needs, optimised free cooling, weekly hourly programming of the indoor air renewal function.

Automatic detection of the disadvantaged room

The SmartComfort 365 system continuously monitors and determines the disadvantaged room by calculating the most suitable water temperature to reach or maintain the desired temperature, while at the same time optimising the water flow in the various radiant circuits to the benefit of energy savings and living comfort.



Living comfort for **365 days** a year

SmartComfort 365 is the technology developed to complement our systems to manage heating, cooling and air treatment systems with maximum efficiency.

At last, the goal of climatic comfort in every living and working environment can be achieved with a speed and efficiency hitherto unheard of. We are not talking about standard comfort, referring to normal heating and cooling systems, but rather comfort tailored to personal needs and the climatic characteristics of the area in which the property is located.

SmartComfort 365 also optimises its operation according to outdoor conditions. The indoor climate is optimised for maximum comfort and the energy bill is reduced.

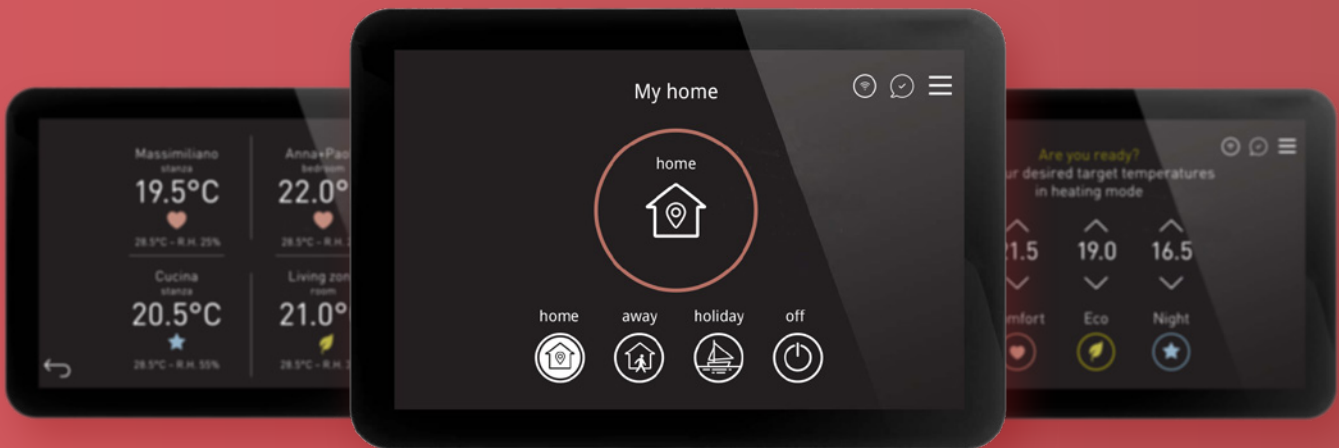

SmartComfort 365

The evolution of technology, the certainty of comfort



Advanced radiant system management

The system memorises usage habits and recognises the climatically unfavourable environment by correcting discomfort.



Integrated system with Start & Stop

The intelligent control continuously calculates the inertia of each individual room by anticipating start-up and shut-down.

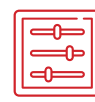

Optimised PID regulation strategy

The technology algorithm allows the radiant system to be managed with maximum efficiency.



Advanced air treatment management

Up to 3 levels of air flow depending on different requirements.



Home automation and voice control system

Using voice devices*, monitoring and controlling the radiant system will be easy and straightforward.



Connection to the Cloud Platform

The platform allows the plant supervision and the display of graphs and statistics.



NEW!



Innovative dual system management

Thanks to the Twin functionality, it is possible to manage up to two hydronic terminals in simultaneous or supplementary mode (e.g. radiant floor, ceiling, wall, fan coil or other water-fed terminal) with the same room sensor.

* compatible with Amazon Echo and Google Home devices

Twin functionality NEW!

Innovative feature that offers the possibility of managing up to two different hydronic terminals within the same house with a single room sensor. The two terminals can work in two different modes:

-  **INTEGRATIVE MODE:** operating priority is always given to a terminal defined as main (radiant at low temperature). The secondary terminal will come into operation to support the former in reaching the comfort setpoint required by the user.
-  **CONTEMPORARY MODALITY:** both terminals will work together to achieve the comfort setpoint requested by the user. In this operating mode, there is no priority and the terminals work simultaneously.

The choice of association between main and secondary terminal can be varied depending on the season.

Examples of use:



Supplementary mode in heating with room setpoint 20 °C

Main terminal: underfloor radiant / Secondary terminal: ceiling radiant

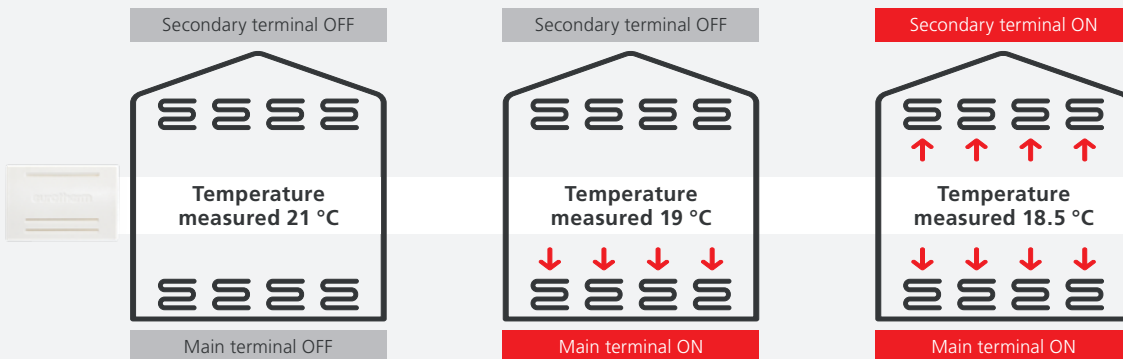

Simultaneous cooling mode with room setpoint 26 °C

Main terminal: ceiling radiant / Secondary terminal: floor radiant

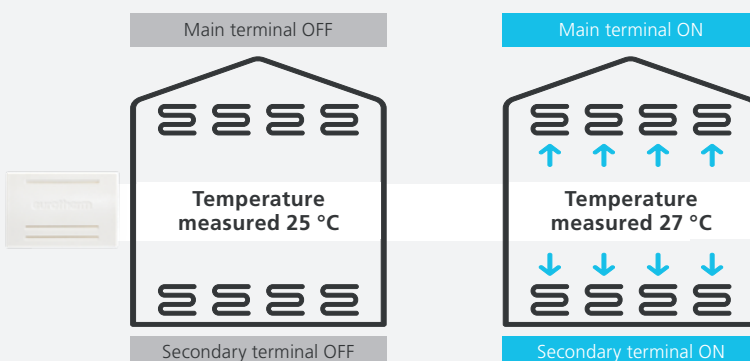

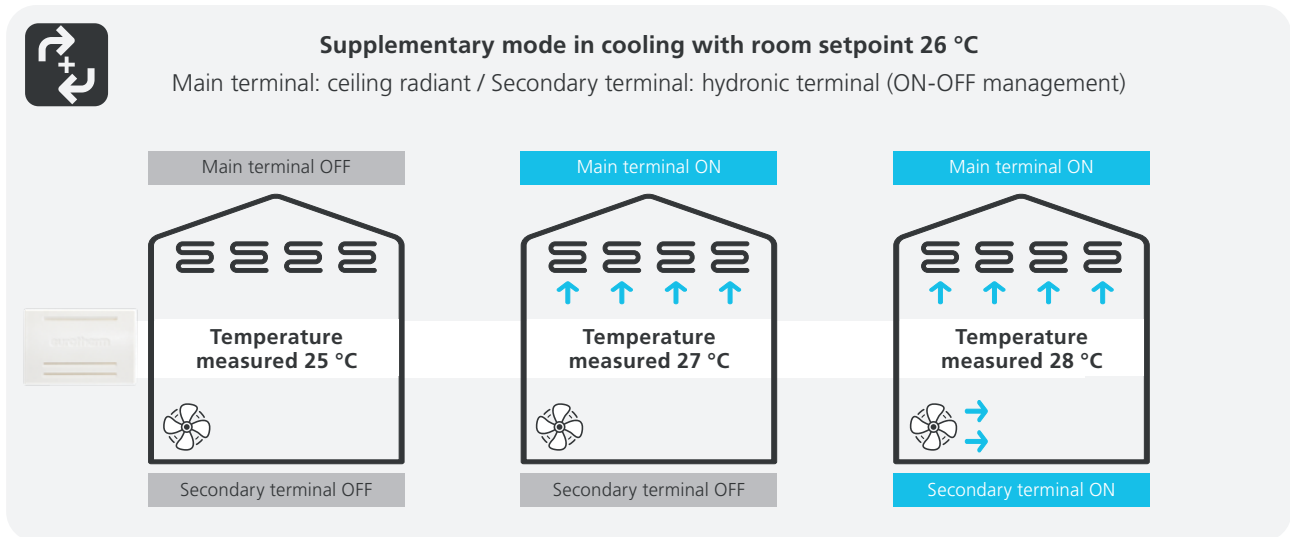

For the Twin functionality to be activated, the hardware components of the SmartComfort 365 control unit must be set up correctly.

What does this mean? Use two different sets of SmartBases, one for each terminal, which will share temperature and humidity data, but from a single room sensor (SmartPoint).

The correct setting of the system with Twin functionality will be set by our service centre during the SmartComfort 365 configuration procedure.

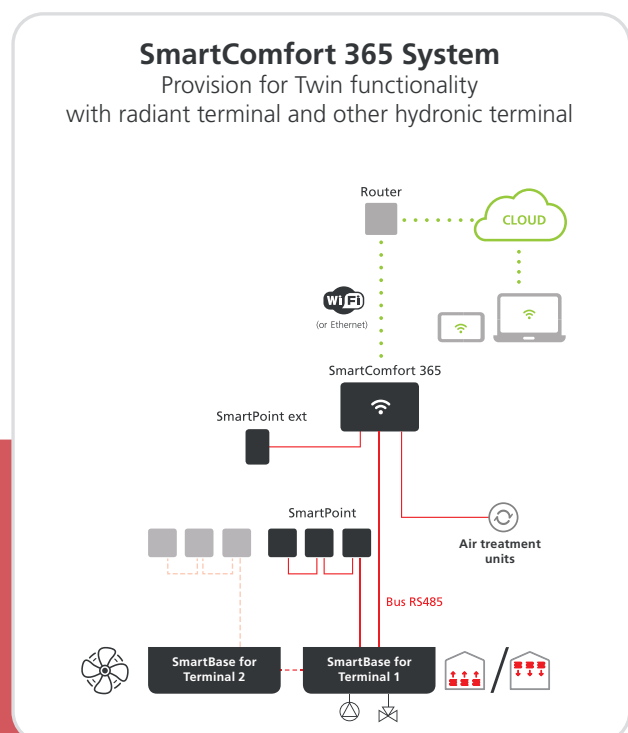
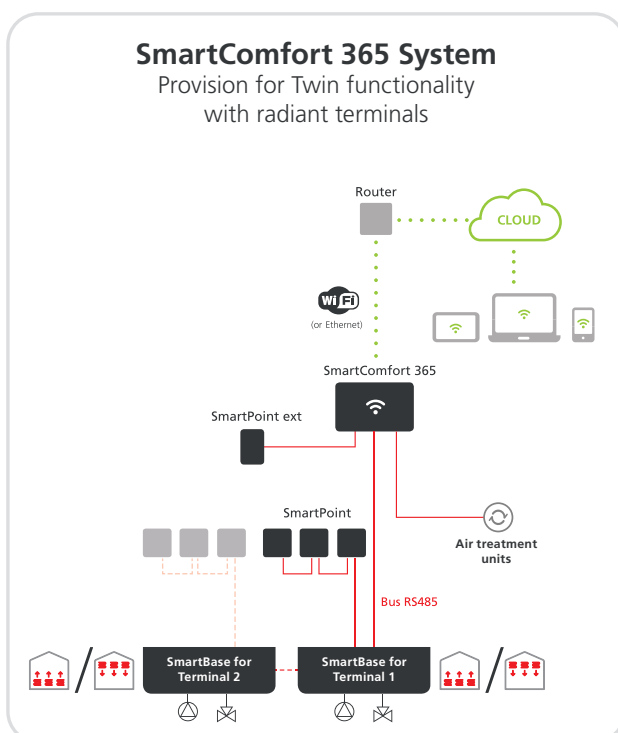

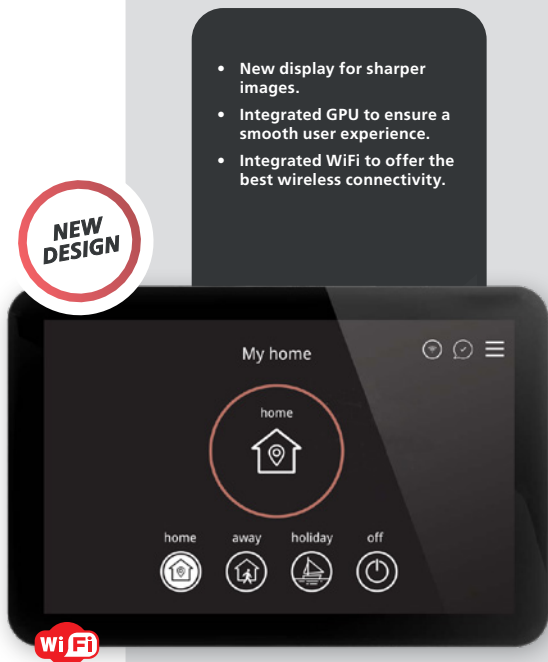

- New display for sharper images.
- Integrated GPU to ensure a smooth user experience.
- Integrated WiFi to offer the best wireless connectivity.

SmartComfort 365 MULTI-ZONE SYSTEM

The SmartComfort 365 climate controller is a management system for radiant systems and air handling machines via PID regulation logic. The SmartComfort 365 is a modular system consisting of the units described below.

Display and control unit to manage climate control. It consists of a 5" capacitive touchscreen display with multitouch technology, a composite shell with a terminal board on the back. The control unit has an indicator light on its bezel to show the operating mode of the system: red for heating and blue for cooling. The control unit includes a motion sensor, SD card slot, WiFi, Ethernet, 2 RS485 serial ports. SmartControl 365 supports the connection of up to 6 SmartBase modules, to control 48 rooms, over bathrooms and 8 SmartAir modules or 8 Deuclima-VMC air machines.

i a round electrical box or 503 box adapter (supplied) is required for wall installation

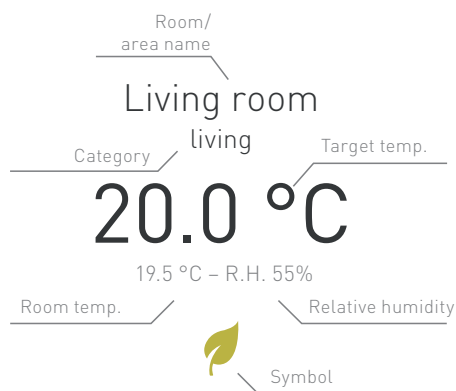

Room name

You can customise the name of the room.

Room category

Assign the room a category to have a standard preset programming, which you can simply modify and adapt to your specific needs.

Target temperature

You can set three target temperatures for each room to be automatically programmed and managed throughout the day.

Symbol legend

- | | |
|---------------------|------------------------------------------|
| Comfort temperature | Temporary Manual |
| Night temperature | Party time (+2 h comfort temperature) |
| Eco temperature | Early bird (advance comfort temperature) |
| Manual mode | Good night (advance night temp.) |



SmartComfort 365 requires initial configuration by authorised personnel





Wrap your home in comfort, wrap your family in well-being

Your habitat is a complex ecosystem. To manage the climate efficiently, rely on SmartOne 365, the intelligent regulation system that stores usage habits and creates customised comfort.

Comfort cannot be standardised; every room is as unique as the person living in it. Building characteristics, people's different habits and the outdoor climate mean that every home needs tailor-made comfort, never static, but dynamic and flexible, in a constant balance between the need for well-being and energy saving. A balance that is achieved with the intelligence of SmartOne 365.



DO YOU WANT TO MAKE YOUR RADIANT SYSTEM SMART?

Scan the QR code with your smartphone and visit the SmartOne 365 control system purchase page.

Or go directly to eurotherm.info/it/SmartOne-365



SmartOne 365

The smart display, small in size



Integrated system with Start & Stop

The intelligent control continuously calculates the inertia of each individual room by anticipating start-up and shut-down.



Optimised PID regulation strategy

The technology algorithm allows the radiant system to be managed with maximum efficiency.



b-VOC sensor to measure air quality

b-VOC sensors help determine air quality by measuring volatile organic compounds emitted by breath.



Home automation and voice control system

Using voice devices*, monitoring and controlling the radiant system will be easy and straightforward.



Connection to the Cloud Platform

The platform allows the plant supervision and the display of graphs and statistics.



NEW!

Dehumidification machine management

For the Eurotherm dehumidifier range and the AirClima Compact dehumidification machine.

* compatible with Amazon Echo and Google Home devices

SmartOne 365

SINGLE-ZONE SYSTEM

SmartOne 365 is the smart display with small dimensions, but great performance. The climate controller is a modular system consisting of the units described below.

A 4" capacitive touchscreen display with multitouch technology, equipped with two relay outputs for managing and regulating the climate of an area, in heating and cooling, with summer dehumidification activation. Inside the display are temperature, humidity, IAQ (air quality) sensors. Thanks to WiFi connectivity, it is possible to connect SmartOne 365 directly to the Cloud platform and App, or connect several devices so that they appear in the same App. For radiant system management, the display uses PID regulation and optimum start/stop. SmartOne 365 is compatible with voice control apps.



i 230 V power supply a round electrical box is required for wall installation

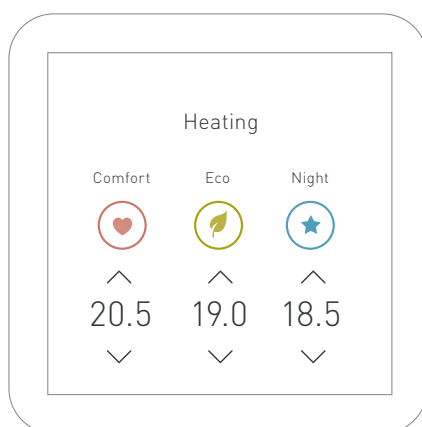

Innovative regulation strategy for saving energy and increasing indoor comfort

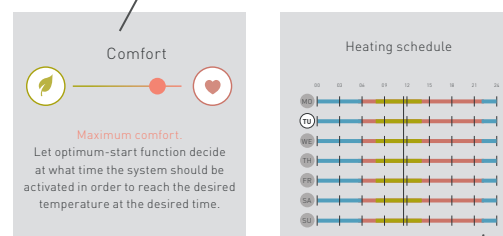

Weekly programming of your preferred climatic comfort in your preferred time slots



SmartOne 365 does not require intervention by authorised personnel

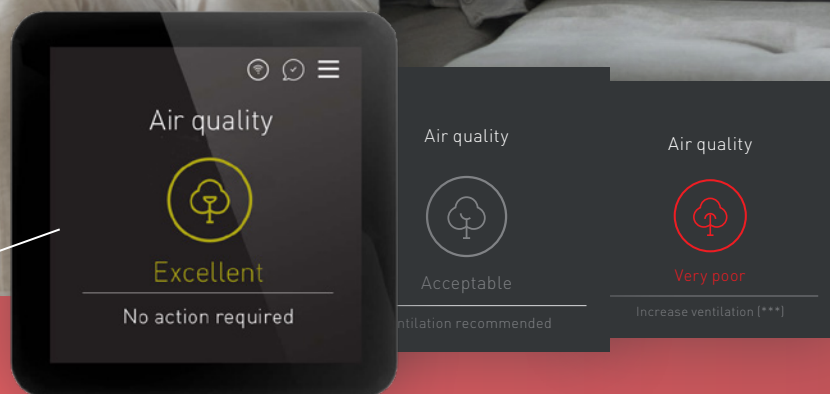

Indoor air quality monitoring

Indoor air quality is a fundamental requirement for comfort and health. Thanks to b-VOC sensors, it is possible to measure the concentration of volatile organic compounds emitted by breathing and understand the right time for air exchange.



Voice control

Using voice control systems, monitoring and controlling the radiant system will be easy and straightforward. Home automation becomes SMART, ask your voice assistant (compatible with Amazon Echo and Google Home devices) to turn the system on or off or to raise or lower the temperature of a room.

“Hey Google, set the temperature in the kitchen to 20 °C”
“Alexa, set the temperature in the living room to 22 °C”

“Away” function

Thanks to active “geofencing”, when all connected devices are out of range of the SmartComfort 365, the “Away” function is activated, automatically resetting the selected temperature to save energy when no one is at home. The location of the user is not monitored.

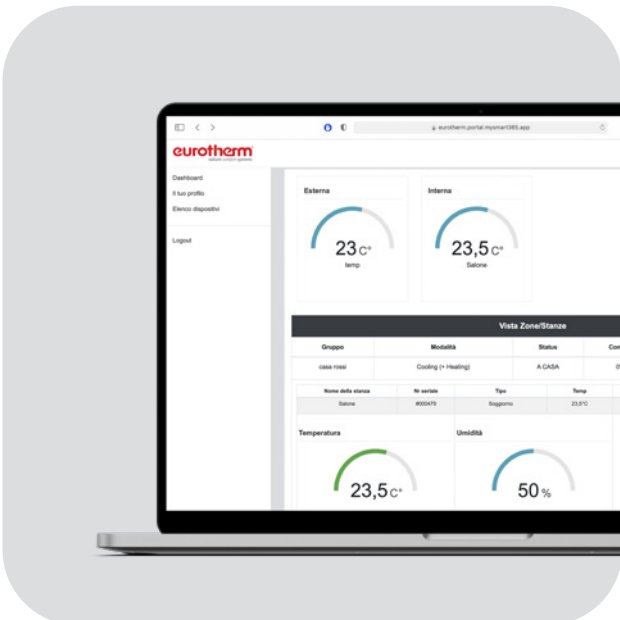

Remote control

The “cloud” platform allows access to a dedicated web portal that enables the management of a user account to view graphs and data on your radiant system, download guides and manuals, ask for assistance and make use of various customised services. The web portal can also be used by specialised personnel (installer, service centre) to directly access the technical data of the system and provide assistance. The account owner can invite family members.



The technology ecosystem for integrated climate management

The new App allows direct access to the cloud platform and remote management of several radiant systems located in different building units. Should the connection fail, the App will automatically synchronise the data with the central system at a later date.

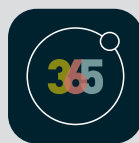
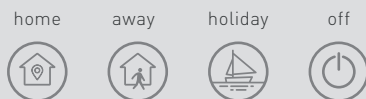

DOWNLOAD THE SMART365 APP

Scan the QR Code with your smartphone camera to download the Smart365 App in the version you prefer.



SmartComfort 365

- New 5" capacitive touchscreen with multitouch technology.
- Temperature/humidity probes in every room, IAQ via SmartOne 365.
- The system proposes the best mode of operation for every room.



SmartComfort 365, the evolution of the SmartComfort intelligent regulation system, is born. Equipped with a 5-inch capacitive multitouch display, SmartComfort 365 has been upgraded both in terms of graphics, which ensure simpler and more intuitive usability, and in terms of updated and implemented functionalities. The latest generation display connects via WiFi or Ethernet to a dedicated cloud platform. Thanks to a personal account, it is possible to: monitor and fully manage the radiant system, ventilation, request and receive assistance, and take advantage of customised and dedicated services. The intelligence "on board" of the device allows vocational management of the system through the most modern smart home applications. The Away function automat-

ically resets the temperature desired to save energy when no one is at home. Renewed in both graphics and 'functionality', the App can remotely monitor and manage one or more systems located even in different buildings and locations. All settings are synchronised with the main device (display) and App operation is guaranteed even in the event of a temporary lack of device connectivity. Using a latest-generation smartphone, it is possible to make use of the NFC (Near Field Communication) function, a technology integrated within the SmartPoint sensors (temperature or temperature/humidity). Bringing your smartphone close to the sensor gives you direct access to the room configuration.

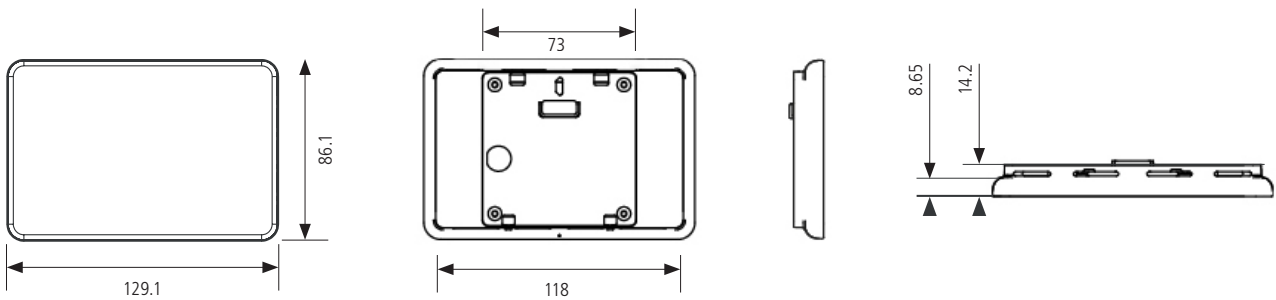

Maximum configuration: 32 Smartpoint 6 Smartbase 8 Smartair 8 Air handling units (units operated via ModBus)



SmartOne 365

- New 5" capacitive touchscreen with multitouch technology.
- Temperature/humidity probes in every room, IAQ via SmartOne 365.
- The system proposes the best operating mode for each room.



SmartOne 365 is Eurotherm's new smart display with small dimensions but big performance. A 4" multitouch capacitive fullglass screen equipped with two relay outputs that control a heating/cooling zone and dehumidification consent. Inside the display are temperature and humidity sensors. Thanks to WiFi connectivity it is possible to connect SmartOne 365 directly to

the Cloud Platform and App, or to link several devices as a single system. For radiant system management, the display makes use of PID regulation, Optimum start/stop. SmartOne 365 is compatible with voice control applications.

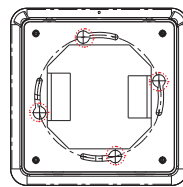
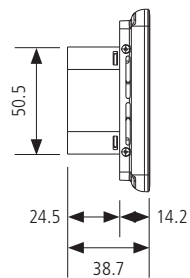
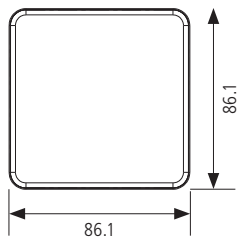

Fastening points at a distance of 60 mm (circled in red in the picture)

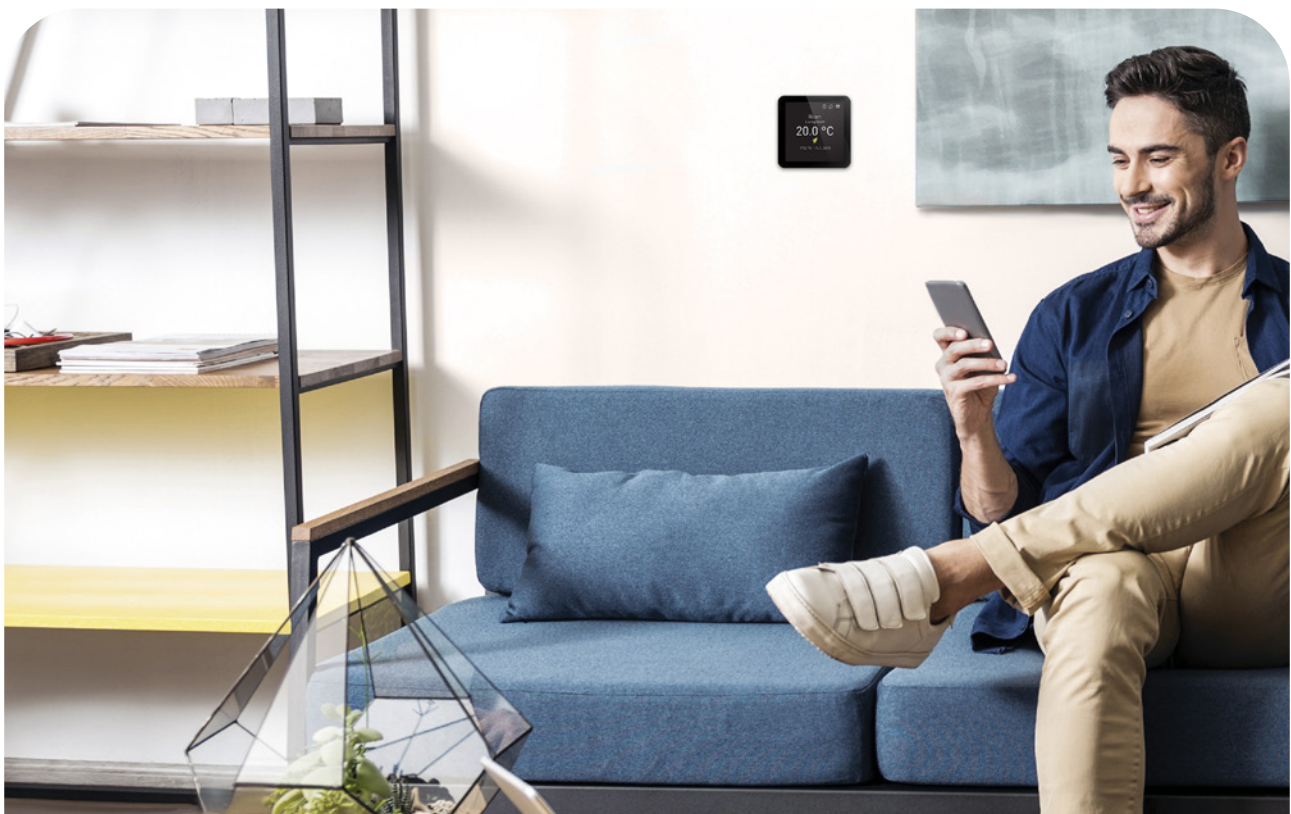

Smart 365 systems **logic diagrams**

SmartControl 365 supports the connection of up to 6 SmartBase modules, to control 48 rooms, over bathrooms, 8 SmartAir modules or 8 Deuclima-VMC air machines. SmartPoint room sensors can be connected via BUS cable or wirelessly.

SmartComfort 365 System

Cable-connected sensors

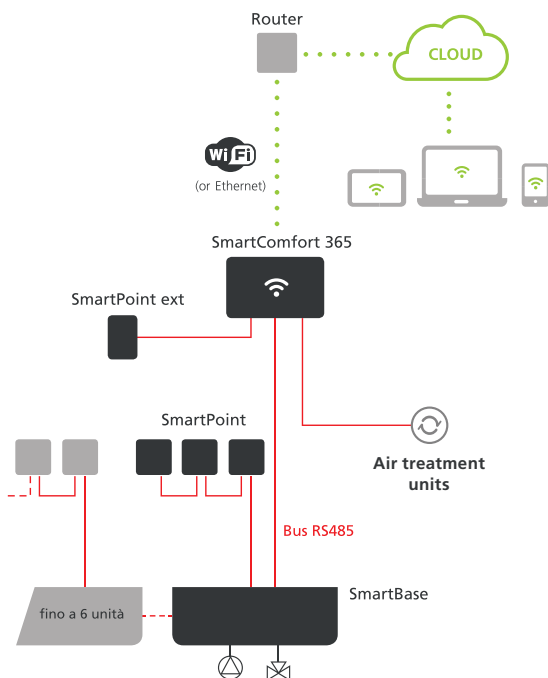

SmartComfort 365 System

Wireless sensors

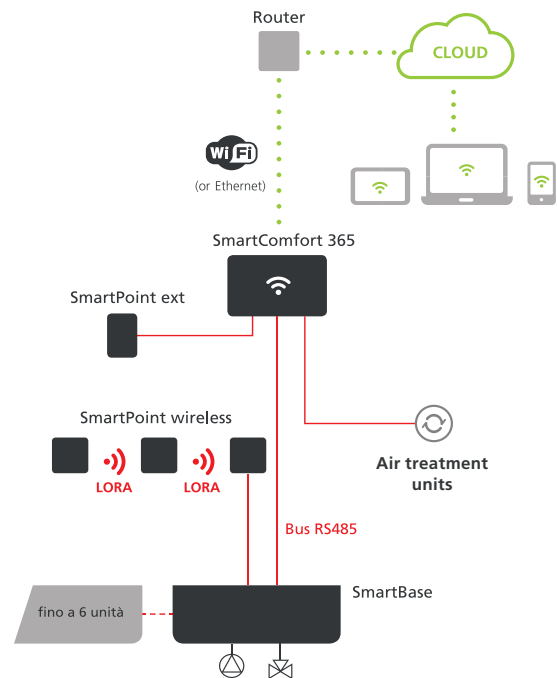

SmartOne 365 can replace SmartPoint probes. Connection to the system can be by cable or wireless depending on requirements. The system can manage a heating and cooling zone and control a dehumidification machine. This configuration can be used to individually manage different zones in the house.

SmartComfort 365 System

SmartOne 365 used as room sensors

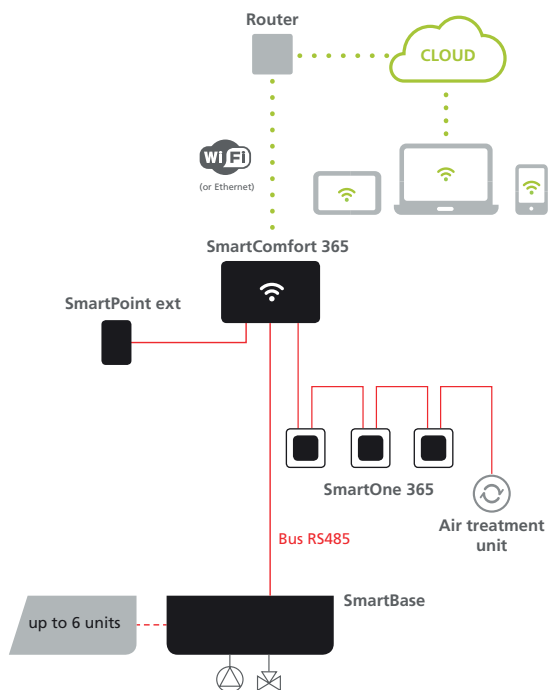

SmartComfort 365 System

in heating and cooling

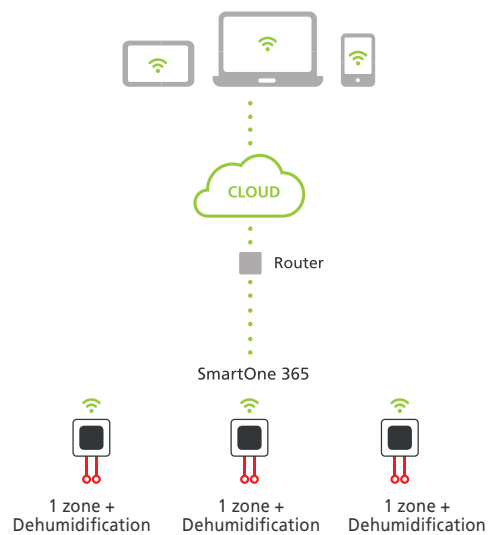

Room sensors

for the SmartComfort 365 ecosystem



SmartPoint 503*

Indoor environment sensor with square box – 503.

5140020401 Probe T
5140020402 T/U probe



SmartPoint 502

Indoor round box room sensor – 502.

5140020411 Probe T
5140020412 T/U probe



Wireless SmartPoint

Indoor room sensor with wireless connection.

5140020406 Access Point T/U
5140020407 wireless T
5140020405 wireless T/U



SmartPoint external probe

Room sensor ideal for outdoor environments.

5140020403 Probe T



Discharge probe

Immersion probe for indoor use as a component of climate control.

5140020404 Probe T

* compatible with the following plates: **BTicino** Living International, Light, Light tech, Magic, Matix series. **Vimar** Plana series, Eikon. **Legrand** series Cross, Vela Quadra, Vela Tonda. **Siemens** Delta Futura series, Delta Geo series.

 NFC technology integrated within SmartPoint sensors

Plate adapters

for the SmartPoint 503 ecosystem

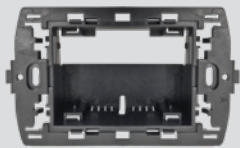

Plate adapter A

compatible with: **BTicino** Livinglight series, Axolute.
Vimar Eikon Evo series. **Ave** S44 series. **ABB** Mylos series.

5930010109 shell + frame



B plate adapter

compatible with:
ABB Chiara series.
Vimar Arkè series.
Gewiss Chorus series.

5930010110 shell + frame



Livinglight Air plate adapter

5930010106

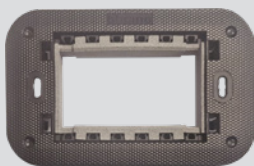

Livingnow plate adapter

5930010117



Axolute Air plate adapter

5930010107

The brain of the SmartBase and SmartAir system

SmartBase and SmartAir take care of the electromechanical management of the radiant system and air handling machines respectively. SmartBase is the connection port to the generation system; through a contact, SmartBase requests 'energy' from the generation system.



SmartBase

5140020201

Actuator module of the hydraulic part of the radiant system capable of managing up to a maximum of 8 rooms, excluding bathrooms.

Head, pump and mixer management, Ecoclima D, Dehumidifier 581 DC.



351 x 112 mm



SmartAir

5140020202

Actuator module capable of managing the Deuclima-VMC unit in dehumidification, cooling and air exchange, separately; alternatively it can manage an air handling machine in dehumidification and cooling.

Ecoclima DC Management / Deuclimatiseur 582 DCC.



351 x 112 mm



Lifetime Warranty

Eurotherm radiant systems are *lifelong* guaranteed by ITAS Assicurazioni. Eurotherm extends the guarantee to the entire lifetime of the radiant system against unintentional damage caused to third parties resulting from manufacturing, assembly and/or design defects.

ITAS
ASSICURAZIONI

eurotherm
radiant comfort systems



CERTIFICATO DI GARANZIA EUROTHERM EUROTHERM WARRANTY CERTIFICATE EUROTHERM-GARANTIEZERTIFIKAT

Eurotherm, per garantire la sicurezza e la tranquillità dei propri Clienti si è dotata delle necessarie coperture assicurative al fine di tutelare l'interesse, affidandosi a ITAS Mutua. La garanzia prevede:

- Assicurazione della Responsabilità Civile del Produttore, **senza limite di tempo, su tutti i prodotti e per l'intera durata contrattuale assicurativa**, per difetti originari di produzione, assemblaggio e/o progettazione, istruzione, imballaggio, contro i danni involontariamente cagionati a Terzi.

I massimali assicurati sono i seguenti:
per sinistro **€ 10.000.000,00**

- Assicurazione della responsabilità Civile dell'Attività, contro Terzi e su tutti i lavori di manutenzione e installazione effettuati da personale specializzato Eurotherm.

I massimali assicurati sono i seguenti:
per sinistro, limite per persona e limite per danni a cose **€ 10.000.000,00**

Copertura valida per segnalazione sinistro entro 24 mesi da messa in pressione con prova tenuta impianto.
ITAS garantisce quindi contro i danni sopra descritti fino alla concorrenza dei massimali indicati nelle certificazioni assicurative allegate e nell'ambito delle rispettive condizioni contrattuali di assicurazione.
La garanzia vale in tutto il mondo escluso USA/CAN/MEX.

To guarantee our Clients' safety and peacefulness, Eurotherm has entered into the proper insurance covers with ITAS Mutua in order to protect our clients' interest. The warranty includes:

- A product liability insurance, **without any temporal limitation, on all products and throughout the entire duration of the contract**, for flaws due to imperfect production, assembly and/or planning, instruction and packaging against damages accidentally caused to Third parties.

The covered limit of liability are:
per accident **€ 10.000.000,00**

- A business liability insurance against Third parties and on all the maintenance and installation works fulfilled by Eurotherm expert staff.

The covered limit of liability are:
per accident, limit per person and limit per damage to goods **€ 10.000.000,00**

The coverage is valid whether the accident is alerted within 24 months from the pressurization with plant tightness test.

Hence, ITAS guarantees against the above-described damages within the limits laid down in the attached insurance certifications and within the consequent insurance's terms and conditions. The guarantee is valid worldwide excluding USA/CAN/MEX.

Um die Sicherheit und Zufriedenheit seiner Kunden zu garantieren, hat Eurotherm einen Versicherungsschutz für alle notwendigen Fälle mit ITAS Mutua abgeschlossen. Die Garantie umfasst wie folgt:

- Unbefristete Haftpflichtversicherung, für alle Produkte und für die gesamte Dauer des Versicherungsvertrages** für Fabrikationsfehler, Montage- und/oder Konstruktionsfehler, Fehler in der Anleitung oder Verpackungsfehler; Haftpflichtversicherung gegenüber Dritten.
Die Obergrenzen sind wie folgt:
€ 10.000.000,00 pro Schadensfall

- Haftpflichtversicherung gegenüber Dritte und für Wartungs- und Installationsarbeiten, die von Spezialisten von Eurotherm ausgeführt werden.
Obergrenzen sind wie folgt:
€ 10.000.000,00 pro Schadensfall. Höchstgrenze pro Person und für Sachschäden
Versicherungsdeckung gültig bei Schadenseröffnung innerhalb von 24 Monaten nach Druckprüfung der Anlage.

ITAS garantiert daher gegen die oben genannten Schäden innerhalb der in den beigefügten Versicherungsbedingungen angegebenen Höchstgrenzen und im Rahmen der jeweiligen vertraglichen Versicherungsbedingungen. Die Garantie gilt weltweit, ausgenommen USA/CAN/MEX.



More quality for the indoor **climate**.
 More value for **well-being**.

The data and characteristics of the products contained in this brochure do not bind Eurotherm SpA Benefit Company in any way in the event of technical or commercial variations or printing errors. Reproduction is forbidden unless authorised in writing by the Management. © Eurotherm SpA Benefit Company

Art. 9290010143 REV.01



Eurotherm SpA Benefit Company
 Pillhof 91 – 39057 Bolzano – Italy
 T +39 0471 63 55 00
 mail@eurotherm.info



ESNA-SOA

eurotherm.info |

